

National Report to ERSWG 6 – Australia

Taiwan, 23 - 25 February 2006

Table of Contents

1. INTRODUCTION.....	3
2. REVIEW OF SBT FISHERIES.....	3
2.1 HISTORICAL FLEET SIZE AND DISTRIBUTION	3
2.2 FLEET SIZE AND DISTRIBUTION.....	8
2.3 DISTRIBUTION OF CATCH AND EFFORT	8
3. FISHERIES MONITORING	11
3.1 CATCH DOCUMENTATION	11
3.2 OBSERVER PROGRAMS	11
3.3 VESSEL MONITORING SYSTEM.....	12
3.4 PORT MONITORING	12
4. SEABIRD INTERACTIONS	12
4.1 THREAT ABATEMENT PLAN	12
4.2 OBSERVED INTERACTIONS WITH SEABIRDS.....	13
5. NON-TARGET FISH.....	15
5.1 SHARKS	18
6. MARINE MAMMAL AND MARINE REPTILE INTERACTIONS	19
7. MITIGATION MEASURES TO MINIMISE SEABIRD AND OTHER SPECIES BYCATCH.....	19
7.1 MITIGATION MEASURES TO MINIMISE SEABIRD INTERACTIONS	20
7.2 MITIGATION MEASURES TO MINIMISE SHARK BYCATCH	24
7.3 MITIGATION MEASURES TO MINIMISE TURTLE INTERACTIONS	25
7.4 MITIGATION MEASURES TO MINIMISE FISH BYCATCH	25
7.5 COMPLIANCE MONITORING SYSTEM.....	25
8. PUBLIC RELATIONS AND EDUCATION ACTIVITIES.....	25
9. LIST OF ATTACHMENTS	27
10. PAPER SUMMARIES.....	26

1. INTRODUCTION

Three Australian fisheries catch Southern Bluefin Tuna (SBT) in varying quantities; the Southern Bluefin Tuna Fishery (SBT Fishery), Eastern Tuna and Billfish Fishery (ETBF) and the Western Tuna and Billfish Fishery (WTBF). As the fisheries have distinct characteristics and management plans, they are separated within this report. The SBT Fishery utilises the method of purse seining for smaller SBT. After capture, these fish are transferred to grow out cages until harvesting. The ETBF and WTBF are both pelagic longline fisheries that incidentally catch SBT. Primary target species in these longline fisheries include yellowfin tuna, bigeye tuna, albacore tuna, broadbill swordfish and striped marlin.

Australia defines its Ecologically Related Species (ERS), or non-target catch, into by-product and bycatch (including the catch of threatened, endangered and protected species). The longline fisheries are multi-species fisheries which, while being relatively selective, catch a range of fish and shark species and interact with a number of species of seabird. Much of the non-target catch in these fisheries is considered to be by-product and is made available to the local market. Discarding of species with little commercial value has been a focus of recent management initiatives. In contrast to the longline fisheries, the SBT Fishery has very little interaction with ERS. The nature of the purse seine allows the operators to be very specific in targeting their catch and as a result few by-product or bycatch species are captured in the nets.

Australia as a whole has invested considerably in the endeavour to reduce the rate of both seabird interactions and capture during longline fishing operations. Through Government and Industry initiatives, the incidence of seabird bycatch has declined markedly in recent years. The longline fishing industries are continuing to develop new and innovative ways to reduce impacts on seabird populations.

This report includes information and data on ERS from Australia's SBT fisheries up to the completion of the 2004-2005 SBT fishing season, which ran from 1 December to 30 November. The fishing in the SBT Fishery for the grow-out farms usually occurs from January to March each year. Data reported for the longline fisheries constitutes the longline fishing seasons which are defined by the Australian financial year, July 1 to June 30. Longlining for SBT occurs primarily in the winter months between May and October.

2. REVIEW OF SBT FISHERIES

2.1 Historical Fleet Size and Distribution

Australians began fishing for SBT in the early 1950s off New South Wales and South Australia and then later, in 1970, off Western Australia. The catch, used primarily for canning, peaked at 21 500 tonnes in 1982.

Progressively over the mid to late 1980s, the Australian catch focused on supplying the Japanese sashimi market. The introduction of an ITQ-based management plan in 1984, based on an Australian TAC of 14 500 tonnes, resulted in the redistribution of quota ownership. In the late 1980s the Australian quota was reduced to 5265 tonnes which led to further restructuring. Since 1992 there has been a progressive increase in the number of SBT taken under farming operations. In the 2004-05 season, this component utilised over 99% of the Australian quota.

From 1990 to 1994, approximately half the Australian quota was taken by Australia-Japan joint venture longliners. With the termination of the joint venture arrangements in 1995, Australian catches again focused on the surface fishery with poling operations supplying the fresh chilled sashimi market and purse seiners providing SBT to farms.

In the past there has been longlining for SBT off New South Wales, Tasmania, Western Australia, with occasional catches in South Australian waters. There were also some purse seine, trolling and poling operations in the Australian Fishing Zone (AFZ). Currently longlining for SBT occurs primarily off south eastern NSW during the winter months (May – October)

To minimise the risk of non-quota take of SBT by longliners off New South Wales and Western Australia, access to the waters through which SBT migrate has been restricted to vessels holding SBT quota since 2000 in NSW and 2001 in WA. This arrangement has resulted in a significant reduction in longline effort in southern areas, and corresponding reductions in seabird and other species bycatch.

Southern Bluefin Tuna Fishery

The area of the SBT Fishery encompasses the entire AFZ and extends onto the high seas (Figure 1). The AFZ is defined consistently with Australia's Exclusive Economic Zone and extends out to 200 nautical miles from the baselines.

The Australian SBT Fishery is managed under the *Southern Bluefin Tuna Fishery Management Plan 1995*, with any commercial catch of SBT managed under that Plan. The Management Plan was recently reviewed to ensure it reflected the current fishing strategies and 'best risk' management strategies. The amended plan came was in force for the 2004-05 fishing season.

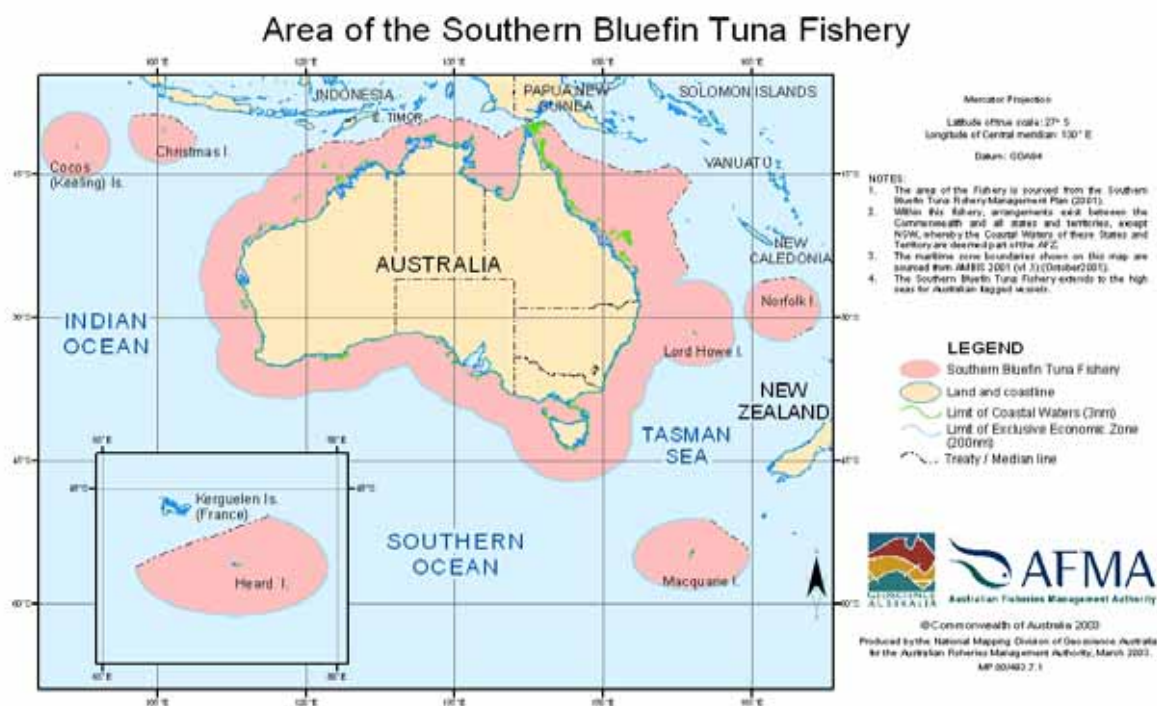

Figure 1: The area of waters of Australia's Southern Bluefin Tuna Fishery.

Eastern Tuna and Billfish Fishery

The ETBF covers the area of the AFZ from the northern tip of Australia, down the east coast to the southern part of Tasmania (Figure 2). The fishery also includes the high seas areas covered by the Convention on the Conservation and Management of Highly Migratory Fish Stocks in the Western and Central Pacific Ocean.

It is a multi-method, multi-species fishery targeting tuna and billfish species. SBT are targeted over the winter months in the south-eastern portion of the fishery off southern NSW. The majority of vessels in the fishery are 15–25 m long and set 200–1000 hooks on monofilament mainlines. Most commonly vessels set 50-150 shots a year and in 2004-05, averaged approximately 82,900 hooks per vessel.

Activities of Australian longliners on the east coast of Australia increased steadily until the end of the 2002-03 financial year but, since that time, have been gradually decreasing. Effort levels for 2004-05 have declined to the levels of the late 1990's which may be attributed to economic conditions, the availability of fish, as well as the management arrangements for SBT which exclude most vessels from fishing in the southern part of the fishery for around three months of the year. However, despite this decline, the total catch per unit effort increased by 10% in 2004-05.

Since late 1996 many Australian longliners have relocated to southern Queensland to fish in an expanding swordfish fishery. The swordfish fishery involves shallow (20–120m) night sets with squid baits and chemical light sticks. In more recent years, fishing activity has shifted offshore and southwards to areas such as near Lord Howe Island around the seamounts during the full moon. The Australian Fisheries Management Authority (AFMA) has recently introduced an interim management arrangement to cap the swordfish catch for the 2006 calendar year.

In late 2005, the *Eastern Tuna and Billfish Fishery Management Plan* was approved for implementation. The target species to be managed under the Plan include albacore tuna, bigeye tuna, billfish, longtail tuna, northern bluefin tuna, Rays bream, skipjack tuna and yellowfin tuna. The catch of the target species will be managed by controlling the total fishing effort expended in the fishery in a season through a Total Allowable Effort, that is, the number of hooks that can be set each year. Rights to the fishery will be determined on an annual basis.

Western Tuna and Billfish Fishery

The WTBF encompasses the area of the AFZ off the northern, western and southern coastline westward from Cape York Peninsula (142°30'E) off Queensland, to 141°E at the South Australian/Victorian boarder (Figures 3a and b). The fishery includes waters seaward of territorial waters (outside 12 nautical miles from the baselines) adjacent to Christmas and Cocos (Keeling) Islands and high seas areas throughout the Indian Ocean consistent with the area of competency of the Indian Ocean Tuna Commission.

All species of tuna caught in southern waters, except SBT and skipjack, are considered to form a part of this fishery. Despite the wide geographic extent of the fishery, the commercially valuable tuna and billfish species are not abundant in the shallow northern waters, consequently fishing activities are concentrated in oceanic waters along the west coast.

Most longline vessels in the fishery are 15–25 m long and set 1000–1500 hooks on monofilament lines, with an average of one set per day. Vessels fish throughout the year with an average of 4 to 6 day trips.

There has been a substantial decrease in the amount of fishing occurring in the WTBF since the peak in 2001-02. Both the amount of effort and catch have been reduced to less than half their previous levels. The factors contributing to this decline have been suggested to include lower fish prices, higher costs for freight and fuel, as well as poor fish abundance and environmental conditions at certain times of the year.

As with the ETBF, a Management Plan for the WTBF was approved for implementation in late 2005. The Plan removes the internal barrier at 34° South which had previously separated the Southern and the Western Tuna and Billfish Fisheries and renamed the entire area the 'Western Tuna and Billfish Fishery'. The Plan provided for a system of individual transferable quota statutory fishing rights (SFR) with the quota species including bigeye tuna, yellowfin tuna, striped marlin and broadbill swordfish. For a season, each SFR entitles an equal share to the total allowable commercial catch for the relevant species.

Area of the Eastern Tuna and Billfish Fishery

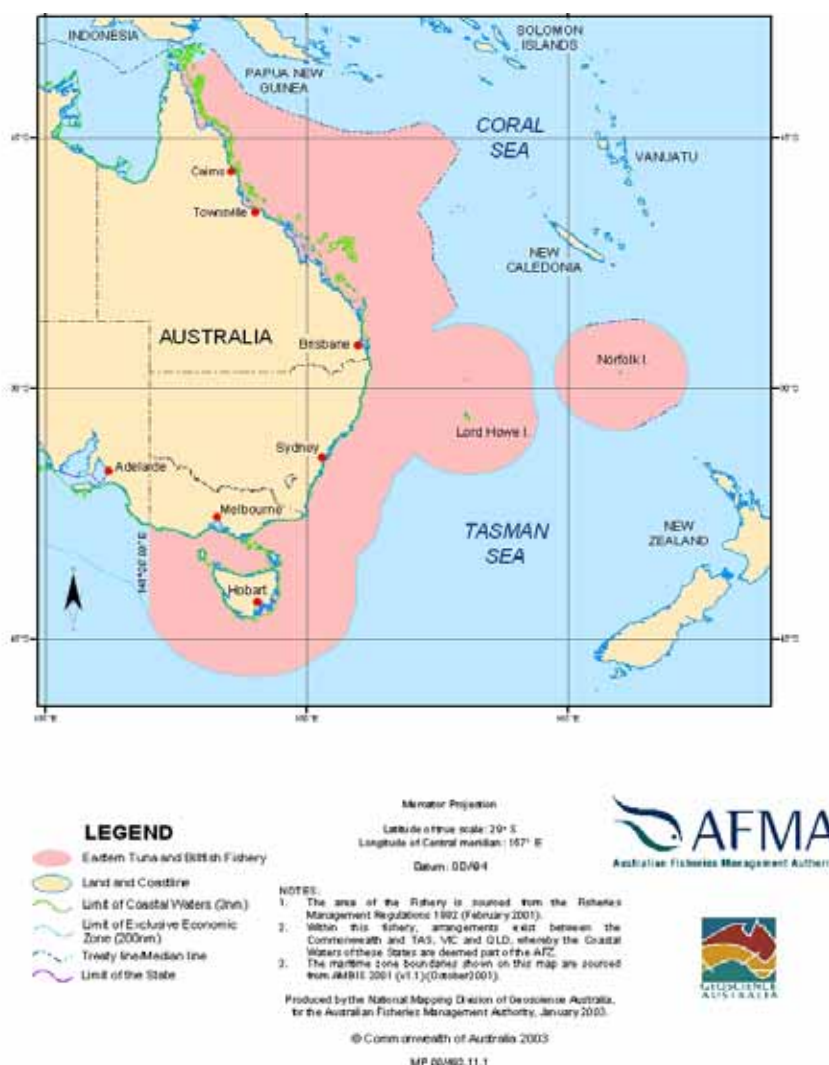

Figure 2: The area of waters of Australia's Eastern Tuna and Billfish Fishery.

Area of the Southern Tuna and Billfish Fishery

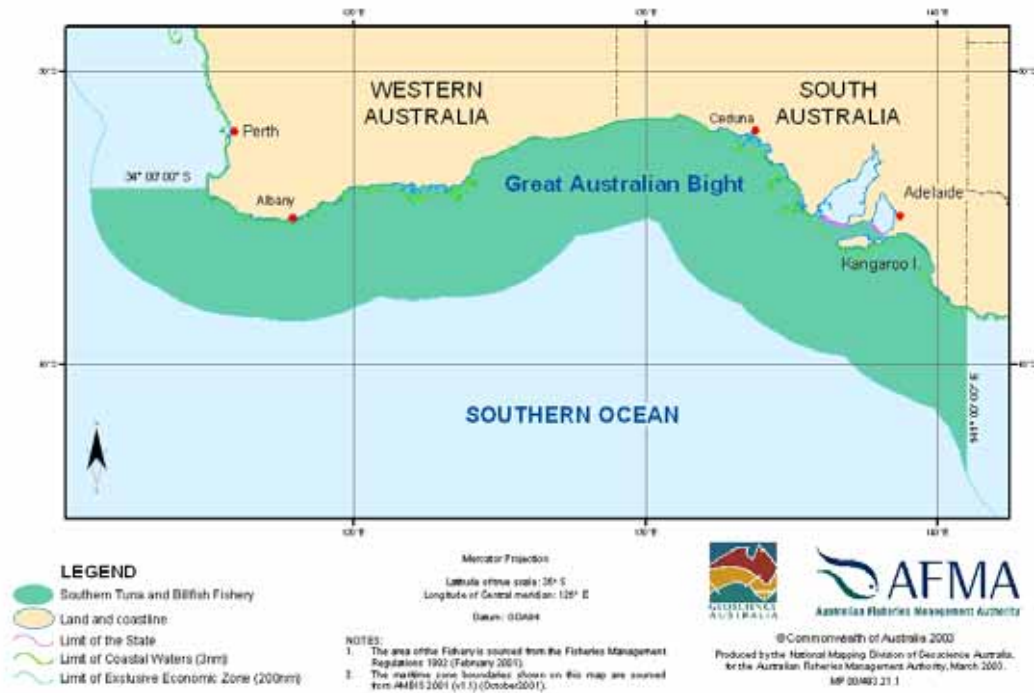

Figure 3a: The area of waters of Australia's Southern Tuna and Billfish Fishery. *

Area of the Western Tuna and Billfish Fishery

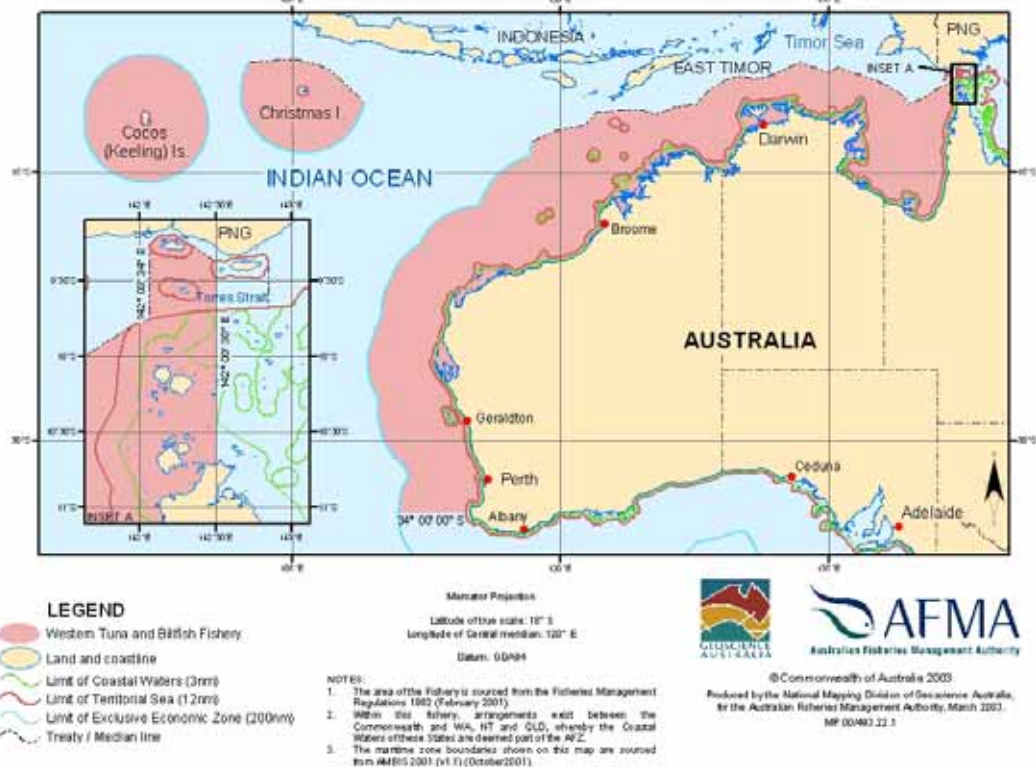

Figure 3b: The area of waters of the Western Tuna and Billfish Fishery. *

* Note: Under the new Management Plan, the internal barriers at 34°South which had previously separated the southern and the western fisheries has been removed and the entire area has been renamed the 'Western Tuna and Billfish Fishery'.

2.2 Fleet size and distribution

Annual Fleet Size and Distribution

In 2004-05, a total of 24 commercial fishing vessels landed SBT in Australian waters, while in 2003-04, 55 commercial fishing vessels landed SBT in Australian waters.

Southern Bluefin Tuna Fishery (South Australia)

The one- to five-year-old SBT, which school from late spring to autumn in surface waters of the eastern Great Australian Bight, were fished by eight purse seiners during the 2004-05 quota year and six in the 2003-04 quota year. Fishing commenced in late December 2004 and finished in March 2005.

Eastern Tuna and Billfish Fishery (New South Wales, Tasmania, Queensland)

During 2004-05, 16 domestic longline vessels participated in the fishery for older juveniles and adults in deeper waters off New South Wales in winter. Longline fishing off NSW commenced in April 2005 and finished in November 2005. During 2003-04, 50 domestic longline vessels participated in the fishery off New South Wales.

No longline vessels, which landed SBT, operated during the 2004-05 quota year off Tasmania or Queensland. In 2003-04, nine longline vessels which landed SBT operated off Tasmania and four off Queensland. For confidentiality reasons all catches from Queensland in 2003-04, are incorporated in the New South Wales longline catch.

Southern and Western Tuna and Billfish Fishery (Western Australia)

No longline vessels caught SBT in this fishery in 2004-05, only two vessels caught small amounts of SBT seasonally as an incidental catch off the WA coastline in 2003-04.

2.3 Distribution of Catch and Effort

The Australian domestic SBT catches for the 2003 and 2004 calendar years were 5287 t and 5062 t, respectively. The 2003 calendar year catch is larger than the previously agreed national allocation to Australia of 5265 t because it represents the aggregation of catches from periods in two quota years. The 2003-04 quota year catch was 5120 t while the catch for the 2004-05 quota year was 5215 t. A catch above the quota occurred in the 2002-03 year. This overcatch of 128 t was paid back during the 203-04 quota year. In August 2005, there was a prosecution for the illegal take of 5764 kg of SBT in the 2003-04 season. Adding these two amounts to the total reported for that season gives 5254 t, which is still under the agreed national allocation to Australia.

The SBT landings for 2004-05 were:

- ***Southern Bluefin Tuna Fishery***
South Australia 5215 tonnes (farmed)
- ***Eastern Tuna and Billfish Fishery***
New South Wales, 35 tonnes (longline)
- ***Western Tuna and Billfish Fishery***
Western Australia 0 tonnes (longline)

SBT purse seined for fish farms in South Australia accounted for 99.3 % of the Australian quota, with the remainder taken by longliners off the New South Wales coast. There were no SBT poled off South Australia or Western Australia or trolled off Tasmania during either season. The Australian catch by gear and state for the quota years 1988-89 to 2004-05 is shown in Table 1. The Australian catch of SBT in calendar years 2003 and 2004 is mapped on Figures 4 and 5 respectively.

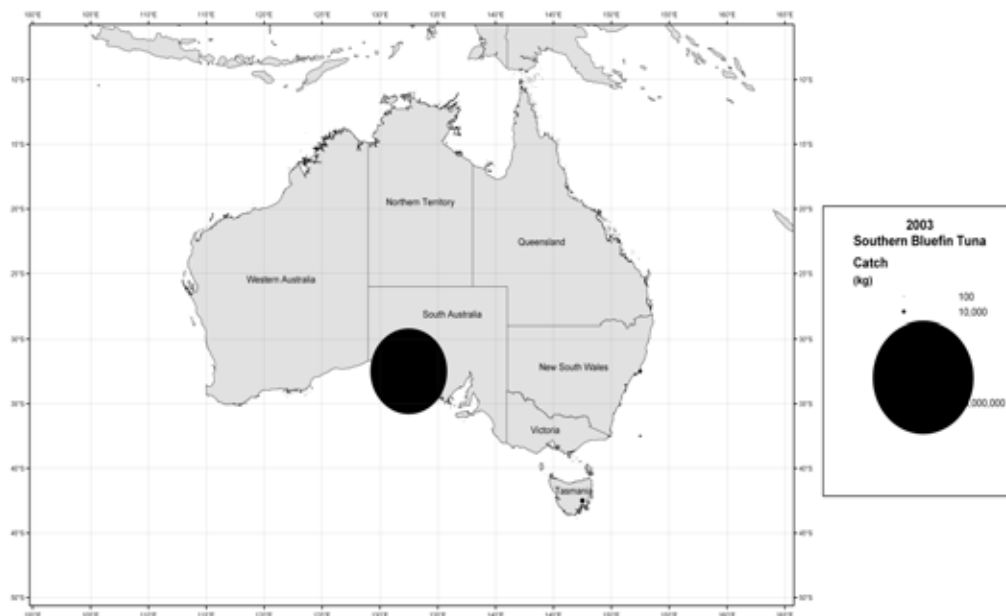

Figure 4: Australian SBT catch in 2003.

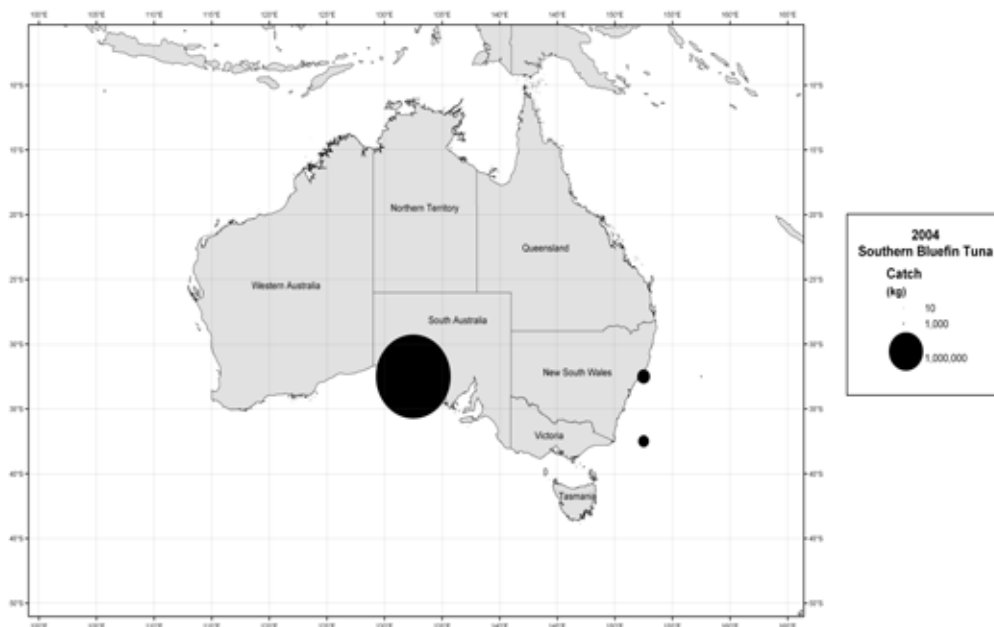

Figure 5: Australian SBT catch in 2004.

Table 1: Australian catch by gear and State for quota years 1998-99 to 2004-05.

Quota Year	Western Australia				South Australia				New South Wales			Tasmania			Large Longliners			Australia Total				Total All Gears
	Albany Pole	Esperance Pole	Long-line	Total	Pole & Purse Seine	Farm Cages	Long-line	Total	Pole & Purse Seine	Long-line	Total	Troll	Long-line	Total	Aust. Charter	Joint-ventur	Total	Domestic Surface	Domestic Long-line	Total Long-line	RTMP	
1988-89	204	221	0	425	4872	0	0	4872	0	1	1	2	0	2	0	684	684	5299	1	685	0	5984
1989-90	133	97	0	230	4199	0	0	4199	0	6	6	14	0	14	0	400	400	4443	6	406	0	4849
1990-91	175	45	0	220	2588	0	0	2588	0	15	15	57	0	57	255	881	1136	2865	15	1151	#300	4316
1991-92	17	0	0	17	1629	138	14	1781	34	90	124	36	20	56	59	2057	2116	1854	124	2240	800	4894
1992-93	0	0	0	0	716	722	68	1506	16	238	254	23	44	67	0	2735	2735	1477	350	3085	650	5212
1993-94	0	0	0	0	621	1294	55	1970	0	286	286	7	105	112	0	2299	2299	1922	446	2745	270	4937
1994-95	0	0	0	0	908	1954	2	2864	0	157	157	4	109	113	0	1295	1295	2866	268	1563	650	5080
1995-96	0	0	0	0	1447	3362	0	4809	28	89	117	0	262	262	0	0	0	4837	351	351	0	5188
1996-97	0	0	0	0	2000	2498	0	4497	7	229	236	2	242	244	0	0	0	4507	472	472	0	4978
1997-98	0	0	^0	0	916	3488	^0	4403	~0	475	475	!0	219	219	0	0	0	4433	664	664	0	5097
1998-99	0	0	^0	0	28	4991	^0	5018	~0	97	97	!0	116	116	0	0	0	5016	216	216	0	5232
1999-00	0	0	^0	0	0	5130	13	5143	0	114	114	0	!0	0	0	0	0	5130	127	127	0	5257
2000-01	0	0	^0	0	0	5162	6	5168	0	32	32	0	!0	0	0	0	0	5162	38	38	0	5247
2001-02	0	0	7	7	0	5234	0	5234	0	*22	*22	0	!0	0	0	0	0	5234	29	29	0	5262
2002-03	0	0	≈0	0	0	5375	0	5375	0	17	17	0	0	0	0	0	0	5375	17	17	0	5391
2003-04	0	0	≈0	0	‡0	4874	†0	4874	0	*226	*226	0	20	0	0	0	0	4874	247	247	0	5120
2004-05	0	0	0	0	0	5215	0	5215	0	35	35	0	0	0	0	0	0	5215	35	35	0	5250

Note that a further 700t of Australian quota was 'frozen' (not allocated) in 1990-91.

^ 1997-98 and 1998-99 WA and SA non-farm catches are included in SA pole and purse seine catch, and in 1999-00 and 2000-01 WA longline catch is included in SA longline due to confidentiality guidelines.

~ 1997-98 to 1998-99 NSW pole and purse seine catches are included in NSW longline catch due to confidentiality guidelines.

! 1997-98 and 1998-99 Tas troll catches are included in Tas longline, and in 1999-00, 2000-01 and 2001-02 Tas longline catch is included in NSW longline due to confidentiality guidelines.

* 2001-02 and 2003-04 NSW longline catch also includes QLD longline catch due to confidentiality guidelines.

≈ 2002-03 and 2003-04 WA longline catch is included in NSW longline due to confidentiality guidelines.

† 2003-04 SA longline catch is included in NSW longline due to confidentiality guidelines.

‡ 2003-04 additional SA purse seine catch that did not go into farm cages is included in SA farm cages catch due to confidentiality guidelines.

3. FISHERIES MONITORING

3.1 Catch Documentation

There are a series of compulsory fishery-specific logbooks and associated catch records that are required by law to be completed by Australian fishers (Attachments 1, 2, and 3). All of the data provided from Logbooks and Catch Disposal Records must be supplied to AFMA within specified time periods. Verification of this data is undertaken through observer programs and as a minimum, through an annual audit process by AFMA.

In addition to detailed catch and effort information, specific reporting forms for threatened, endangered or protected species are included with fishery logbooks in all Australian Commonwealth fisheries (Attachments 4, 5 and 6).

AFMA has recently implemented a system of 'prior reporting' in the ETBF. Operators are required to inform AFMA of their impending arrival in port to alert authorities that they have catch on board their vessel.

3.2 Observer Programs

Observer programs for the purse seine and longline sectors have been in place for a number of years. The program began in the ETBF in September 2001 and in April 2003 in the SBTF. Since their inception, the observer coverage in the SBT Fishery and the ETBF has been consistently greater than 10% of the fishing effort. A pilot observer program also began in the WTBF in April 2003 and has been continued despite the reduction in fishing over the past few years.

AFMA Observers are professionally trained and briefed to collect and verify fishery data on both target (SBT) and non-target species. The information collected by observers is extensive and provides management agencies with an accurate and descriptive representation of the fishery. The observer reports include details of daily fishing operations, the mitigation measures employed and any non-target interactions (Attachment 7). In terms of ERS species, the number (and weight where appropriate) of each species caught, the life status and whether it was retained or discarded is recorded for each shot observed.

Purse seine sector

For the SBT purse seine fleet operating out of Port Lincoln, the design coverage was intended to be 10% of the fishing effort. In 2005, observers covered a total of 26 sea days on purse seine vessels and an additional 27 days on tow cage operations. The observed fishing was 11% of the effort for the fishery and estimated 12% of catch.

Longline sector

The observer program has been running for five years in the ETBF and in that time, the coverage in the areas where SBT are likely to be caught has remained above the 10% required by CCSBT. The distribution of observers throughout the fishery has been somewhat unbalanced due to a number of factors including a higher abundance of seabirds in southern regions of the fishery and an increased coverage associated with the implementation of SBT fishing zones. AFMA is currently attempting to pursue a more evenly distributed coverage of observers.

3.3 Vessel Monitoring System

All Australian longline vessels, including those that catch SBT, are required to operate Integrated Computer Vessel Monitoring Systems (ICVMS) whilst fishing and transiting to and from fishing areas. This allows real-time vessel position and activity reporting to a central VMS operations area at the AFMA.

Australian purse seine and tow vessels catching and towing SBT for the Australian farm fishery off Port Lincoln are required to report their locations and catch details on a daily basis. This may be done by ICVMS, or at sea by satellite phone, mobile phone or fax.

3.4 Port Monitoring

Australian fisheries officers conduct random inspections of landings at key SBT ports, as well as at-sea boardings and inspection of vessels taking SBT in the longline and purse seine fisheries.

Compliance risk assessments for all sectors taking SBT are completed annually and a specific compliance operational plan is then developed and implemented annually for each fishery.

4. SEABIRD INTERACTIONS

4.1 Threat Abatement Plan

The vulnerability of seabirds to capture during longline fishing operations throughout the world has been well documented. Oceanic longline fishing operations have been listed as a key threatening process by Australia under its *Environmental Protection and Biodiversity Conservation Act 1999* (EPBC Act). This listing required the Australian Government to develop a Threat Abatement Plan as a means of mitigating the threat to seabirds through the implementation of conservation measures and coordination of national action to alleviate the impact of longline fishing activities on seabirds in Australian waters. The Plan is known as the *Threat Abatement Plan for the Incidental Catch (or Bycatch) of Seabirds During Longline Fishing Operations* (TAP) and applies to all longline fisheries under Commonwealth jurisdiction. The original TAP came in effect in 1998.

The Australian Government is currently developing a revised TAP. The original Plan had a life of five years, expiring in 2003. Under the requirements of the EPBC Act, it was necessary to review the original TAP and to determine its success against the TAPs objectives through an examination of data and the success of management arrangements. Substantial progress has been made toward reducing the impacts of fishing on seabirds. The draft prescriptions in the revised TAP recognise this success and seek to further reduce the incidental capture of seabirds.

Consistent with the objectives and prescriptions of the TAP, Australia has implemented conditions aimed at reducing seabird mortality through fishing permits. These are detailed in Section 7 (Seabird Mitigation Measures) of this report.

4.2 Observed Interactions with Seabirds

Southern Bluefin Tuna Fishery

There are very few recorded incidences of seabirds interacting with fishing vessels or gear in the SBT Fishery. Three seabird interactions were observed during the 2004-05 fishing season. The first interaction occurred when a shearwater was observed floating dead in the water during the hauling operation, however the observer was unable to determine how the interaction occurred. The second recorded interaction took place when setting the gear when the observer saw a Storm Petrel collide with the vessel and die on impact. The final interaction recorded for the SBT Fishery occurred when a shearwater became entangled in the net. The observer was able to recover the bird and release it alive. Anecdotal evidence from observers suggests caution against extrapolation of this data because the interactions were vessel specific.

Eastern Tuna and Billfish Fishery

Of the fisheries that interact with SBT, the only one with a substantive problem with seabird interactions is the ETBF. With the implementation of the original TAP in 1998, a large proportion of the longline fleet on the east coast began to set their lines during the night to avoid interactions with albatross species. In doing so, they dramatically reduced the catch of albatross but increased the catch of shearwaters. Through a number of at-sea trials with a variety of mitigation measures, the catch of shearwaters has been consistently reduced and has reached a level under the 0.05 seabirds/1000 hooks set as the performance indicator under the TAP (Figure 6).

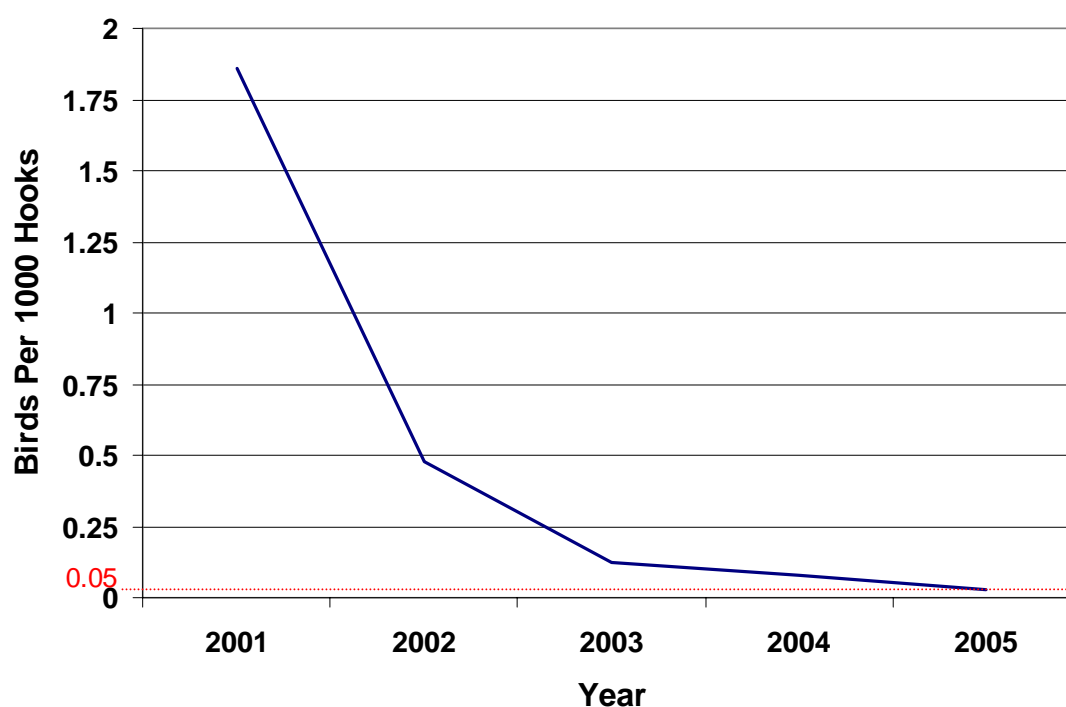

Figure 6: Decline in seabird interactions since the implementation of mitigation measures in 2001.

Scientific advice indicated that the highest abundances of seabirds occur south of 30° South and as such, the original TAP stipulated that the mitigation measures would apply south of this line. Table 2 describes the distribution of seabird interactions divided into latitudinal bands. Higher

abundances, particularly of shearwaters, occur between 30-35° South. Shearwaters breed and nest on Lord Howe Island, located at 31°30' South, therefore this area requires particular attention from any adverse impacts.

Table 2: Spatial distribution of observed seabird interactions in the ETBF 2002-04.

		25-30° South			30-35° South			35-40° South		
		2002	2003	2004	2002	2003	2004	2002	2003	2004
Total Birds	Spring	0	0	2	24	19	1	0	0	1
	Summer	0	0	2	69	11	8	1	1	0
	Autumn	2	0	0	70	7	4	1	0	0
	Winter	0	0	6	4	2	0	4	6	10
	Total	2	0	10	167	39	13	6	7	11
Birds per 1000 hooks	Spring	0	0	0.03	0.42	0.43	0.09	0	0	0.11
	Summer	0	0	0.05	1.53	0.31	0.21	0.10	0.07	0
	Autumn	0.11	0	0	0.84	0.16	0.23	0.03	0	0
	Winter	0	0	0.07	0.05	0.02	0.00	0.80	0.10	0.43
	Average	0.03	0	0.04	0.71	0.23	0.13	0.23	0.04	0.13

Observers record all interactions including light and heavy contact with fishing vessels or gear, number of birds chasing or diving on baits (Table 3), as well as abundance counts of birds seen around fishing vessels while fishing is in progress (Table 4).

Table 3: Observed interactions with ETBF longline gear in 2004-05.

Species	Light contact with vessel or gear	Heavy contact with vessel or gear	Chasing or diving for baits or target species	Chasing or diving for non-target species	Total	CPUE (# per 1000 hooks)
Sooty shearwater	214	5	70	0	289	0.66
Fleshy-footed shearwater	31	5	63	2	101	0.23
Great-winged petrel	36	0	30	0	66	0.15
Short-tailed shearwater	15	0	5	0	20	0.05
Black-browed albatross	0	0	11	0	11	0.03
Cape petrel	4	0	1	2	7	0.02
Petrels	0	0	5	0	5	0.01
Wandering albatross	1	0	3	0	4	0.01
Yellow-nosed albatross	0	0	4	0	4	0.01
White-chinned petrel	0	0	2	0	2	<0.01
Antarctic giant petrel	1	0	0	0	1	<0.01
Shy albatross	1	0	0	0	1	<0.01

Table 4: Seabird species composition observed around ETBF longline vessels during setting in 2004-05.

Species	Species Composition (%)
Fleshy-footed shearwater	69.0
Great-winged petrel	7.0
Sooty shearwater	6.0
Short-tailed shearwater	5.9
White-chinned petrel	3.9
Petrels	3.2
Black-browed albatross	1.6
Cape petrel	<1
Yellow-nosed albatross	<1
Wandering albatross	<1
Parkinson's petrel	<1
Wilson's storm petrel	<1
Shy albatross	<1
Royal albatross	<1
South polar skua	<1
Grey-headed albatross	<1
Great skua	<1
Hall's giant petrel	<1

Western Tuna and Billfish Fishery

The prevalence of seabirds on the west coast of Australia is considerably less than that of the east coast. In addition to the lower abundance of birds, the majority of the fleet in the WTBF targets broadbill swordfish and therefore operates at night. While observer data is only available for recent years during which time fishing activity has been very low, the data indicates that seabird interactions are below the limit of 0.05 birds/ per 1000 hooks prescribed by the TAP.

5. NON-TARGET FISH

Whilst the target species in Australia's longline fisheries are primarily tuna and billfish, there is a wide range of other fish species taken in these fisheries. For instance, observers in the ETBF reported 60 different species of fish caught in all shots set during the 2004-05 year that targeted SBT. Summaries of the composition of observed catch, including non-target species, recorded for the ETBF and WTBF are detailed in Tables 5 and 6 respectively. This data represents all observer records since the inception of the respective observer programs. The information includes life status and whether retained or not for Australia's longline fisheries.

The observed catch composition in the ETBF where SBT was nominated as the target species shows that, as would be expected, yellowfin tuna and albacore tuna are the most abundantly caught species in the ETBF (Table 5). In the WTBF, blue shark represents the largest catch, closely followed by swordfish. Crocodile shark, bigeye tuna, albacore tuna and yellowfin tuna make up the majority of the remaining catch composition for this fishery (Table 6).

CCSBT-ERS/0602/National Reports-Australia

Table 5: ETBF observed longline catch composition where SBT was identified as the target species (27/09/01 to 13/10/05).

Common Name	Species Code	Number	CPUE (# per 1000 hooks)	Life Status		Fate	
				Alive	Dead	Discarded	Retained
Albacore	ALB	2721	13.77	603	2118	61	2660
Yellowfin tuna	YFT	1879	9.51	1393	486	83	1796
Southern bluefin tuna	SBF	1260	6.37	889	371	679	581
Swordfish	SWO	442	2.24	185	257	29	413
Longnosed lancetfish	ALX	269	1.36	206	63	265	4
Blue shark	BSH	223	1.13	202	21	215	8
Ray's bream	POA	212	1.07	150	62	1	211
Escolar	LEC	218	1.10	189	29	20	198
Bigeye tuna	BET	253	1.28	190	63	18	235
Shortfinned mako shark	SMA	102	0.52	74	28	24	78
Shortnosed lancetfish	ALO	59	0.30	16	43	58	1
Sunfish	MOP	64	0.32	64	0	64	0
Oilfish	OIL	32	0.16	27	5	10	22
Pelagic ray	STI	25	0.13	24	1	25	0
Dolphinfish	DOL	19	0.10	16	3	1	18
Snake Mackerel	GES	19	0.10	8	11	18	1
Bigeye thresher shark	BTH	10	0.05	7	3	9	1
Skipjack tuna	SKJ	15	0.08	3	12	0	15
Striped marlin	MLS	17	0.09	11	6	2	15
Bronze whaler shark	BRO	9	0.05	9	0	6	3
Crocodile shark	PSK	6	0.03	5	1	6	0
Porbeagle	POR	5	0.03	1	4	5	0
Thintail thresher shark	ALV	8	0.04	6	2	8	0
Rudderfish	CEO	4	0.02	4	0	0	4
Cubiceps	CUP	3	0.02	3	0	0	3
Frostfish	BEH	2	0.01	2	0	2	0
Manta Ray	RMB	3	0.02	3	0	2	1
Opah	LAG	2	0.01	2	0	0	2
Barracouta	SNK	1	0.01	1	0	1	0
Basking Shark	BSK	1	0.01	1	0	1	0
Cookie-cutter Shark	ISB	1	0.01	1	0	0	1
Dusky whaler shark	DUS	3	0.02	3	0	1	2
Leatherback Turtle	DKK	1	0.01	1	0	1	0
Long finned mako	LMA	0	0.00	0	0	1	0
Shortbill spearfish	SSP	0	0.00	0	0	1	0
Silky shark	FAL	4	0.02	4	0	3	1
Slender barracuda	BAC	0	0.00	0	0	1	0
Tiger shark	TIG	1	0.01	1	0	0	1
unknown	UNK	1	0.01	1	0	1	0
Wahoo	WAH	1	0.01	0	1	0	1
White Cardinalfish	EGD	1	0.01	0	1	1	0
Grand Total		7896		4305	3591	1623	6276

CCSBT-ERS/0602/National Reports-Australia

Table 6: WTBF observed longline catch composition (27/04/03 to 17/10/05).

Common Name	Species Code	Number	CPUE (no per 1000 hooks)	Life Status		Fate	
				Alive	Dead	Discarded	Retained
Blue shark	BSH	1152	6.07	1071	81	1048	104
Swordfish	SWO	1043	5.49	418	625	120	923
Crocodile shark	PSK	473	2.49	398	75	473	0
Longnosed lancetfish	ALX	384	2.02	173	211	383	1
Bigeye tuna	BET	330	1.74	249	81	95	235
Yellowfin tuna	YFT	211	1.11	105	106	35	176
Albacore	ALB	208	1.10	25	183	26	182
Escolar	LEC	185	0.97	145	40	41	144
Dolphinfish	DOL	176	0.93	156	20	79	97
Oilfish	OIL	99	0.52	80	19	65	16
Southern bluefin tuna	SBF	53	0.28	27	26	52	1
unknown	UNK	49	0.26	31	18	47	2
Shortnosed lancetfish	ALO	49	0.26	15	34	49	0
Shortfinned mako shark	SMA	46	0.24	34	12	27	19
Dusky whaler shark	DUS	37	0.19	36	1	37	0
Striped marlin	MLS	31	0.16	25	6	31	0
Pelagic ray	STI	31	0.16	25	6	30	1
Skipjack tuna	SKJ	31	0.16	5	26	17	14
Pelagic Stingray	PLS	30	0.16	28	2	30	0
Sunfish	MOP	29	0.15	29	0	29	0
Indo-Pacific Sailfish	SFA	24	0.13	9	15	24	0
Thintail thresher shark	ALV	21	0.11	12	9	21	0
Hammerhead Shark	SPN	13	0.07	4	9	12	1
Shortbill spearfish	SSP	10	0.05	5	5	10	0
Rudderfish	CEO	10	0.05	8	2	2	8
Black marlin	BLM	9	0.05	5	4	9	0
Oceanic whitetip shark	OCS	9	0.05	8	1	6	3
Sandbar Shark	CCP	8	0.04	8	0	8	0
Silky shark	FAL	8	0.04	7	1	7	1
Manta Ray	RMB	6	0.03	6	0	6	0
Whaler Shark	CVX	5	0.03	4	1	5	0
Short tailed shearwater	PFT	5	0.03	0	5	5	0
Smooth hammerhead	SPZ	5	0.03	0	5	4	1
Wahoo	WAH	5	0.03	5	0	0	5
Slender barracuda	BAC	3	0.02	1	2	3	0
Loggerhead turtle	TTL	3	0.02	3	0	3	0
Pelagic Thresher	PTH	3	0.02	1	2	3	0
Leatherback Turtle	DKK	3	0.02	3	0	3	0
Northern Bluefin Tuna	BFT	2	0.01	2	0	0	2
Blue Marlin	BLZ	2	0.01	1	1	2	0
Bigeye thresher shark	BTH	2	0.01	2	0	2	0
Ray's bream	POA	2	0.01	2	0	0	2
Barracudas nei	BAR	2	0.01	2	0	2	0
Southern Rays Bream	BRU	2	0.01	1	1	0	2
Dogshark	DGZ	2	0.01	2	0	2	0
Pufferfish	GPF	2	0.01	2	0	1	1
Silvertip Shark	ALS	1	0.01	1	0	1	0
Frostfish	BEH	1	0.01	0	1	1	0
Pomfret	BRA	1	0.01	1	0	0	1
Basking Shark	BSK	1	0.01	0	1	1	0
Snake Mackerel	GES	1	0.01	0	1	1	0
Pacific (Olive) Ridely	LKV	1	0.01	1	0	1	0
Long finned mako	MAR	1	0.01	1	0	1	0
Porbeagle	POR	1	0.01	0	1	1	0
Tiger shark	TIG	1	0.01	1	0	1	0
Grand Total		4823		3183	1640	2863	1942

Records of non-target species taken in Australia's SBT surface fishery, and longline fisheries are largely derived from logbook records, and are generally unverified. There is concern that logbook data do not reflect the true quantity of non-target species taken by longline vessels.

The only observed interactions with any ecologically related species in the SBT Fishery involved skipjack tuna and Chinaman leatherjackets, *Nelusetta ayraudi*. Less than ten skipjack tuna were noted as mortalities in the purse seine shots but others (between 150 and 200) were noted swimming with the caged SBT following transfers. There were 131 leatherjackets noted as bycatch by one observer and 112 by the second observer.

5.1 Sharks

The prevalence of shark captures in Australia's fisheries has received considerable attention over the past several years. Historically, longliners have often used wire trace to reduce damage to gear and gear loss caused by sharks. Sharks are unable to break free from wire leaders and are landed, usually dead, so the hook can be retrieved. To reduce the incidence of shark deaths, the use of wire trace has been banned in the ETBF (2005) and WTBF (2004).

In addition, to reduce the impact of indiscriminate shark finning, longline operators are restricted to a 20 shark trip limit and must land trunks with fins attached. This limit however, does not apply to great white and grey nurse sharks which are no-take species protected under Australian law.

These regulations are likely to have reduced the shark captures in the longline sector.

Southern Bluefin Tuna Fishery

Bycatch of sharks during pole-and-line and purse seine fishing (including farm operations) for SBT is very minimal. Sharks taken as bycatch are able to be released before the net is retrieved and fish are transferred to towing cages. Sharks are known to interact with tow cages containing SBT that are being towed back to farms. Some of these are released alive.

Eastern Tuna and Billfish Fishery

The observed catch of sharks in the ETBF is summarised in Table 5. The observer program shows that blue sharks and mako sharks account for most of the reported catch, with lower catches of threshers, hammerheads, silky sharks and dusky sharks. Most of the shark bycatch is currently discarded, species that tend to be retained are mako, ground shark and dusky shark although the information on this is limited (Table 5). The most commonly caught shark species, blue shark, appear to be most often landed alive and discarded. The spatial distribution of shark catches in the ETBF is not well understood and little scientific information currently exists on the abundance of shark species.

There have been very few interactions with great white or grey nurse sharks observed during fishing operations in the ETBF. In the first reported interaction in a number of years, a great white shark was caught in 2004-05.

Western Tuna and Billfish Fishery

The observed catch of sharks in the WTBF is summarised in Table 6. In recent years the highest proportion of the catch in the WTBF has been made up by blue sharks mostly landed alive and discarded (Table 6). As a consequence of the lack of scientific population studies in the WTBF and the wider Indian Ocean, the data does not yet exist to definitively indicate what the

sustainable levels of blue shark catch may be. Crocodile sharks have also been caught in relatively high numbers in the fishery in the past, these also tend to be discarded (Table 6).

6. MARINE MAMMAL AND MARINE REPTILE INTERACTIONS

The longline and SBT purse seine fisheries all have a very low incidence of marine mammal and reptile interaction compared with many other fisheries both within Australia and throughout the world. Based on information available in logbooks for Australia fishers, from 35-70 marine turtles are hooked annually in the entire ETBF and WTBF longline fisheries, i.e. including shots when they are not targeting SBT.

Observer data from the ETBF indicates that leatherback turtles are the most commonly caught species and that, in general, most turtles are able to be released alive. ETBF observer data for the 2004-05 fishing year shows that only one turtle was recorded when targeting SBT.

7. MITIGATION MEASURES TO MINIMISE SEABIRD AND OTHER SPECIES BYCATCH

In December 1998, Australia's Oceans Policy established principles and actions to pursue ecologically sustainable development in Australian fisheries. The policy commitment included a requirement, under the EPBC Act, to prepare strategic assessment reports for all Commonwealth fisheries and those fisheries with an export component to ensure they are managed in an ecologically sustainable manner. The reports consider the impacts of the fishery on species caught in the fishery and the broader marine environment. Strategic Assessments have been completed for the SBT Fishery and the longline fisheries and continue to guide the development of improved management arrangements to reduce the ecological impacts of the Australian fisheries catching SBT.

Measures to reduce the ecological impacts of the fisheries catching SBT rely initially on the analysis of fishery dependant and independent data collected through observer programs, fishery logbooks and targeted fishery research activities. As data is collected, and the impacts of SBT fishing operations on ERS become clearer, strategies to reduce these impacts continue to be developed and refined.

In this context, Australia has:

- Continued to use catch and effort logbooks to collect data on the catch of target and non-target species;
- Introduced observer programs in the SBT surface fishery; and its longline fisheries targeting SBT, including specific reporting requirements for threatened, endangered and protected species;
- Initiated a range of at-sea programs to trial strategies to reduce the incidental mortality of seabirds caught during longlining operations;
- Introduced detailed strategies to reduce bycatch and impacts on ecologically related species, performance measures to monitor progress, and reporting and review targets to assess the effectiveness of these strategies, and refine them where necessary. An important part of these strategies is the development of fishing industry Codes of Practice to reduce impacts on ERS.

Australia has commenced an ecological risk assessment for each of its fisheries with an aim of quantifying impacts on ecologically related species and the marine environment. The purpose of the project is to undertake ecological risk assessments for major fisheries managed by the Australian government and to develop a framework for future risk assessments as additional information becomes available. The results of the project will help inform fisheries management agencies of priorities for research, data collection, monitoring and management and ensure there is a high level of confidence in the results that can be verified against data.

The ecological risk assessments rely on existing biological and catch information and consider five ecosystem components – target species, by-product and bycatch species, protected species, habitats and communities. The assessments will categorise various species into high, medium or low risk on the basis of their susceptibility to capture by the various fishing methods and the ability for species populations to recover.

7.1 Mitigation Measures to Minimise Seabird Interactions

Current Mandatory Measures

Regulations to reduce seabird bycatch in Australia's longline fisheries were put in place in February 2001. At that time, the regulatory conditions were separated by the latitudinal line of 30° South. In 2004, with the accumulation of observed data on the incidence of seabird interactions, permit conditions were amended to raise the line to 25 ° South in the ETBF. The line at 30° South has remained in the WTBF.

ETBF vessels operating south of latitude 25° South are required to:

- Deploy a tori pole apparatus that complies with specifications during line setting;
- Use weighted branchlines in order to operate during daylight hours. Weighting regimes of 60 and 100 grams are specified;
- Operate only at night if weighted lines are not in use;
- Ensure that all bait used is properly thawed;
- Prevent the discharge of any offal during line setting; and
- Avoid the discharge of any offal during line hauling. If this is not possible, offal may only be discharged while the vessel is not underway or from the opposite side of the vessel to that where the line is being hauled.

ETBF vessels operating north of latitude 25° South are required to:

- Carry a tori pole apparatus that complies with specifications;
- Prevent the discharge of any offal during line setting; and
- Avoid the discharge of any offal during line hauling. However if this is not possible, offal may only be discharged while the vessel is not underway or from the opposite side of the vessel to that where the line is being hauled.

WTBF vessels operating south of 30° South are required to:

- Set longlines after nautical dusk and before nautical dawn;
- Deploy a tori pole apparatus that complies with specifications during line setting;
- Ensure that all bait used is properly thawed;
- Prevent the discharge of any offal during line setting; and
- Avoid the discharge of any offal during line hauling. If this is not possible, offal may only be discharged while the vessel is not underway or from the opposite side of the vessel to that where the line is being hauled.

WTBF vessels operating north of latitude 30° South are required to:

- Carry a tori pole apparatus that complies with specifications;
- Prevent the discharge of any offal during line setting; and
- Avoid the discharge of any offal during line hauling. However if this is not possible, offal may only be discharged while the vessel is not underway or from the opposite side of the vessel to that where the line is being hauled.

Current Voluntary Measures

In addition to mandatory measures and scientific trials taking place under the longline TAP, some operators in the ETBF longline sector are adopting voluntary measures to reduce seabird bycatch. These include:

- Puncturing of the swim bladders of thawed baits to assist in sinking the baits out of the diving reach of seabirds;
- The use of bait casting machines on suitable vessels;
- The selection of gear which minimises the probability of seabird bycatch;
- Promoting the safe release of all seabirds caught alive on longlines;
- Promoting night-setting north of 25° South in the ETBF and north of 30° in the WTBF.

Codes of Practice have been developed for the ETBF and WTBF. The Codes are completed by the relevant industry organisations and set out principles and standards of behaviour for responsible fishing practices. They act as guides for operators and are designed to be stored on the vessels.

Measures under Development and Testing

During the past four years Australia has conducted a number of seabird bycatch reduction trials including a variety of line-weighting trials, an underwater setting chute, side setting and an underwater bait setting capsule (Table 7). Scientific studies have been conducted to investigate the most appropriate sink rate of live and dead baits, the differences of bait types and a variety of weighted branchline arrangements.

Table 7: Mitigation measures under development/testing in Australian longline fisheries.

Mitigation measure	Lead agency and collaborators	Results to date	Planned development/testing	Expected completion date
Seabirds				
Day-setting of longlines with different mitigation measures: 1) Underwater setting chute, 2) Double tori line with 60 gm swivel, 3) Double tori line with 38 gm swivels	AFMA and ETBF operators	None of the three measures reduced overall seabird capture rate to below 0.05 birds/1000 hooks. Trials with the underwater setting chute had higher catch of seabirds than trials with the 38 and 60 gm swivels. The level of seabird-gear interaction did not vary between trials. Detailed in CCSBT-ERS/062/Info. 03	N/A	Completed
Effect of bait type, bait life status, swivel weight and bottom length on sink rates of pelagic longlines.	DEH	The greatest effect was from bait status with live bait sinking more slowly than dead and the difference in sink time between live and dead bait increasing as depth increases. Sink rates of branch lines can be expedited by use of: <ul style="list-style-type: none"> • Dead bait, • Heavier swivels and, • To surface depths at least (and with dead bait but not live bait) by use of short bottom lengths 	N/A	Completed
Weighted branchline arrangements.	AFMA and ETBF operators	N/A	Trialing different weighting regimes, 60 or 100gm, 2 – 3.5 m from hook.	2007

CCSBT-ERS/0602/National Reports-Australia

Mitigation measure	Lead agency and collaborators	Results to date	Planned development/testing	Expected completion date
Utility of dyed bait for seabird bycatch mitigation in pelagic longline fisheries	DEH and Australian National University	N/A	Using specro-radiometry to assess the reflectance spectrum of dyes and therefore assess how the various dyes appear to seabirds. This approach is essential because birds are particularly sensitive to UV wavelengths and many dyes are active in the UV range. This project includes some at sea trials.	2006
New Tori line design	AFMA/SEANET and ETBF operators	A new tori line has been designed and distributed to all ETBR and WTBF operators. The design consists of a 100 m backbone from which paired and double-paired streamers form a curtain to the water (Attachment 8).	SeaNet is continuing to improve the design by making minor alterations aimed at increased efficiency and ease of use.	Ongoing
Sharks				
The effects of wire-leaders on longline catch rates	BRS and AFMA	Observers completed 8 trips on longliners off North Queensland in 2005 comparing the performance of wire- and nylon monofilament leaders.	Another 20 trips are planned for 2006, with data analyse to be conducted in conjunction with circle hook work (below).	December 2007
Turtles				
The effects of circle hooks on longline catch rates	BRS, Belldi Consultancy and AFMA	Outfitted 3 longliners and completed 3 trips in 2005 testing the experimental design and developing data collection protocols (Stage I report available).	More extensive study involving about 20 trips off eastern and western Australia in 2006–07, depending on funding.	December 2007

Results have been variable but have indicated that the use of weighted lines and tori lines are successful in reducing the incidence of seabird capture and death (Table 7). This is in part, due to the relative simplicity of these approaches and therefore the high level of correct usage across the longline fleets.

Operators are also encouraged to develop and experiment with mitigation measures to suit their own situations and vessels.

A new tori line has been developed and provided to all operators currently participating in the ETBF and WTBF (Attachment 8). The design creates a substantial curtain of different coloured streamers which not only prevent seabirds from diving on the baits but also aims to prevent seabirds from approaching the vessel.

7.2 Mitigation Measures to Minimise Shark Bycatch

Current Mandatory Measures

Australia has developed a National Plan of Action for the Conservation and Management of Sharks (Shark-plan 2003) in line with the FAO International Plan of Action for the Conservation and Management of Sharks (IPOA-Sharks). In line with the implementation of the actions within the Shark-plan regulations have been put in place in the longline sector to minimise shark bycatch and prevent indiscriminate finning.

The regulations applying to the ETBF and WTBF are:

- A ban on the use of wire traces.
- A limit of 20 sharks per trip, excluding school shark, gummy shark, elephant fish of the Families Callorhynchidae, Chimaeridae and Rhinochimaeridae and sawshark. This limit however, does not apply to Great White and Grey Nurse Sharks which are no-take species protected under Australian law.
- Fishing permit holders are prohibited from carrying, retaining, or landing all shark dorsal, pectoral, caudal, pelvic and anal fins that are not attached to their carcass.
- Fishing permit holders are prohibited from carrying, retaining and landing livers obtained from sharks unless the individual carcasses from which the livers were obtained are also landed.

Measures under Development and Testing

Trials are currently underway to examine the impact of the ban on the use of wire trace in the ETBF (Table 7).

7.3 Mitigation Measures to Minimise Turtle Interactions

Measures under Development and Testing

Despite the comparatively rare occurrence of longline interactions with marine turtles, the Australian government has recognised the potential for these interactions to threaten the survivability of the species. As a result, a three-phase project has been established with the aim of quantifying the relative effects of circle and tuna hooks on catches of target and common non-target species (Table 7).

The objective of the proposed trials will be to demonstrate if the mitigation solutions, principally large circle hooks and mackerel-type bait, that have been shown to be effective in other pelagic longline fisheries, are economically viable and commercially practical in our pelagic longline fisheries. The project results will assist fishery managers in making management decisions regarding future bycatch mitigation policies that are commercially and operationally practical for Australia's fisheries.

7.4 Mitigation Measures to Minimise Fish Bycatch

Current Mandatory Measures

Effective from 27 July 1998, the commercial take of blue and black marlin was banned under Australian law. Regulations specified that blue and black marlin must be returned to the water irrespective of life status.

7.5 Compliance Monitoring System

Routine SBT compliance activities include at sea patrols, including random inspection of vessels at sea. Australian authorities have conducted aerial surveillance and other compliance activities to monitor the use of tori poles and night setting. Port monitoring of landed catch and reconciliation of logbooks and other catch records, as well as vessel compliance with fishing permit conditions (such as Tori Pole regulations) are conducted in key ports each season. Vessel Monitoring Systems are used to ensure cost effective and efficient vessel monitoring and fishery compliance operations.

For the purse seine fishery, vessels are required to report daily positions and catch details in real time. Random at sea inspections are conducted and all SBT taken are sampled for average weight and filmed by video as they are transferred into floating harvest cages. This process forms the basis for Australia's quota monitoring and compliance with CCSBT member allocations.

8. PUBLIC RELATIONS AND EDUCATION ACTIVITIES

All of the strategies in place or being trialed by Australia to reduce impacts of SBT fishing on ERS include a level of education and extension to increase their effectiveness. Specific activities to educate fishers on ERS issues are included in the TAP, National Plans of Action for Sharks, Bycatch Action Plans for both the tuna purse seine and longline fisheries, and during the Ecological Risk Assessment project currently underway.

In addition, Australian observers are briefed to educate fishers on their responsibilities to complete logbooks and other data sources, and to use mitigation strategies to reduce impacts on ERS. This information is passed onto ship masters and crews during observer trips and while in port. Staff from Australian fisheries management agencies are regular visitors to key SBT fishing

ports and engage in education and extension activities during these visits. Australian fisheries management agencies also provide education materials in the form of booklets, videos, posters, media releases and other written material for further education of vessel skippers and crews. Industry representatives are continuing to refine existing codes of practice to reduce the environmental impacts of Australian tuna fisheries.

In the latter half of 2005 an extensive education program was conducted in the ports of the ETBF and the main ports of the WTBF. The program was designed as an interactive workshop focused at skippers and crew and aimed to educate and involve fishers in the new direction of fisheries management – ecologically-based fisheries management – which takes into consideration the impacts of fishing on the entire ecosystem not just the target species. They were also informed of the project to carry out ecological risk assessments for all fisheries managed by the Australian Commonwealth Government and the potential implications of this project including the ability for fishery managers to better direct research and management expenditure.

Participants were taught about the implementation of new fishing practices designed to eliminate the accidental capture of seabirds, to reduce the unintended take of sharks and to increase the mortality of turtles taken during longline fishing operations. The participants were shown how to correctly assemble and use the recently designed tori line and informed of the importance of adhering to the prescribed line-weighting approach to reduce the catch of seabirds. They were also shown how to use de-hooking and line-cutting equipment to reduce the impacts on sharks and turtles.

Feedback from the fishing industry indicated that the program was well received and has led to a greater understanding of the impacts of fishing on both target and ecologically related species.

9. LIST OF ATTACHMENTS

- Attachment 1 – Australian Purse Seine and Pole Daily Fishing Log
- Attachment 2 – Australian Pelagic Longline Daily Fishing Log
- Attachment 3 – Commonwealth Catch Disposal Record
- Attachment 4 – Wildlife and Other Protected Species List
- Attachment 5 – Recapture Sheet for all Tagged Fish, Tagged Animals and Banded Seabirds
- Attachment 6 – Recapture Sheet for all Tagged Fish/Animal Recaptures
- Attachment 7 – Longline Observer Manual
- Attachment 8 – Tori line design and assembly

10. PAPER SUMMARIES

CCSBT-ERS/0602/04

Review of international instruments relevant to ecologically related species: data requirements and recommendations for sharks and seabirds

Stewardson, C., Findlay, J. and Bensley, N.

ABSTRACT

This paper was prepared for the sixth meeting of the Ecologically Related Species Working Group of the CCSBT, Taiwan, 20–23 February 2006. The paper provides an overview of relevant international instruments to assist CCSBT members in the development of recommendations to monitor and reduce the impact of SBT fishing on ecologically related species (ERS). Specifically, the paper focuses on (i) data requirements to assist in monitoring and assessing the impact on ERS, and (ii) recommendations for reducing bycatch of sharks and seabirds.

Brief overviews are presented of ten key international instruments and a listing of other relevant bodies which recommend actions relevant to ERS. The key instruments include:

- 1. The International Plan of Action for the Conservation and Management of Sharks (IPOA-SHARKS)** encourages States to adopt a national plan of action for the conservation and management of shark stocks (NPOA-SHARKS) if their vessels conduct directed fisheries for sharks or if their vessels regularly catch sharks in non-directed fisheries. States should also strive to cooperate through regional fisheries organisations with a view to ensuring the sustainability of shark stocks, including, the development of subregional or regional shark plans.
- 2. The International Plan of Action for Reducing Incidental Catch of Seabirds in Longline Fisheries (IPOA-SEABIRDS)** encourages States to adopt a national plan of action for reducing the incidental catch of seabirds in longline fisheries (NPOA-SEABIRDS) where there is concern about the occurrence of incidental catches of seabirds. States should also strive to cooperate through regional fisheries organisations to reduce the incidental catch of seabirds in longline fisheries.
- 3. The Convention on the Conservation of Migratory Species of Wild Animals (CMS), including the Agreement of the Conservation of Albatrosses and Petrels (ACAP),** encourages all Parties to mitigate known threats to the conservation of albatross and petrel populations. The CMS considers the incidental catch of seabirds during longline fishing operations as the most significant threat to albatrosses. In relation to fishing activities under the auspices of a regional fisheries organisation, the Parties shall consider information and

evaluations from that organisation, and shall adopt, in its area of competence, the measures agreed by that organisation for reducing the incidental taking of albatrosses and petrels.

4. **The Convention on Biological Diversity (CBD)** is dedicated to promoting sustainable development, and encourages cooperation between Parties in developing methods for the sustainable use of biological resources.
5. **The Convention on International Trade in Endangered Species of Wild Flora and Fauna (CITES)** aims to ensure that international trade in specimens of wild animals and plants does not threaten their survival. All international trade of species listed under CITES must first be authorised through a licensing system. The Conference of the Parties to the Convention (Twelfth Meeting, Santiago, Chile, 3-15 November 2002) resolution on Conservation and Management of Sharks urges Regional Fisheries Management Organisations to take steps to undertake the research, training, data collection, data analysis and shark management plan development outlined by FAO as necessary to implement the IPOA-SHARKS.
6. **The [Convention for the Conservation of Antarctic Marine Living Resources \(CCAMLR\)](#)** aims to conserve marine life of the Southern Ocean. All fishing and associated activities in the area to which this Convention applies shall be conducted in accordance with the provisions of the Convention. This includes adhering to conservation measures to reduce the incidental mortality of seabirds during longline fishing and data reporting requirements on bycatch, including fine-scale catch and effort for all species, by species.
7. **International Commission for the Conservation of Atlantic Tunas (ICCAT)** has conducted assessments of blue shark and mako shark bycatch. In 2005 their Sub-Committee on Bycatch recommended that Contracting Parties and non-Contracting Parties (collectively termed CPCs) continue to develop and conduct observer programs to collect accurate data on shark and other bycatch, report on total catches (landings and discards), institute mitigation measures to reduce or eliminate bycatch interactions and undertake that further research on shark bycatch and biology.
8. **Indian Ocean Tuna Commission (IOTC)** in 2005 adopted recommendations on incidental mortality of seabirds, including: that all CPCs should report on the status of their NPOA-Seabirds and be urged to implement the IPOA-SEABIRDS, should collect and provide information on interactions with seabirds and when feasible the Scientific Committee should assess the impact of incidental seabird catch. The resolution on the conservation of sharks was also adopted in 2005, including that all CPCs: shall annually report shark catch data, shall take measures to require their fishers fully utilise their retained shark catch, shall require their vessels to not have fins onboard that total more than 5 percent of the weight of shark on board, encourage the release of live sharks, and undertake research to make fishing gears more selective, such as avoiding use of wire trace.
9. **Inter-American Tropical Tuna Commission (IATTC)** in 2005, adopted a resolution on incidental mortality of seabirds that all CPCs should report on their NPOA-SEABIRDS and are urged to implement the IPOA-SEABIRDS and when feasible assess the impact of incidental catch, including the identification of geographic areas where there could be interactions. The resolution on the conservation of sharks was also adopted in 2005 including, that each CPC: should establish and implement an NPOA-Sharks, take measures to require their fishers fully utilize any retained shark catch, shall require their vessels to not have fins onboard that total more than 5 percent of the weight of shark on board, encourage release of live sharks, undertake research to make fishing gear more selective and annually

report catches, effort, landings and trade by species and provide any historic data. In 2006 the Scientific Committee will provide preliminary assessment of stock status of key species.

10. [Western and Central Pacific Fisheries Commission \(WCPFC\)](#) in 2005 considered and will soon adopt recommendations on incidental mortality of seabirds including call for all Members and Cooperating Non-Members (CCMs) to implement the IPOA-SEABIRDS and report on this, collect and provide information on interactions with seabirds, take steps necessary to ensure comprehensive recording and monitoring of seabird interactions. The draft resolution on non-target fish species was also considered in 2005 and will soon be adopted including: that all CCMs shall encourage fishers to avoid capture of, and prompt release of all non-target species, the WCPFC will seek advice on steps to improve information, including enhancing observer and port sampling programs, review of mitigation measures for non-target and review mitigation measures.

Other relevant bodies (international tuna research and management organisations and tuna related sites) which recommend general/specific actions relevant to: (i) data requirements to assist in assessing and monitoring the impact of tuna fishing, and/or (ii) recommendations for reducing bycatch of ERS are also listed. These include Pacific Islands Forum Fisheries Agency (FFA), South Pacific Regional Environment Programme (SPREP), [Secretariat of the Pacific Community \(SPC\)](#), [Asia-Pacific Economic Cooperation \(APEC\)](#), Northwest Atlantic Fisheries Organisation (NAFO), North Pacific Fishery Management Council (NPFMC), Organisation for the Protection of Responsible Tuna Fisheries (OPRT), Pacific Islands Forum Secretariat (PIFS), High Seas Task Force, Food and Agriculture Organization (FAO) and the Division of Ocean Affairs and the Law of the Sea (DOALOS).

(Agenda Item 5.1)

CCSBT-ERS/0602/04

The impact of pelagic longline fishing on the flesh-footed shearwater

Puffinus carneipes in Eastern Australia

Baker, G.B. and Wise, B.

ABSTRACT

The flesh-footed shearwater (*Puffinus carneipes*) is a medium-sized seabird (ca. 700 g) that is incidentally killed during longline fishing operations. We examined the levels of bycatch in Australia's Eastern Tuna and Billfish Fishery and developed a model to examine the impact of this fishery on the eastern Australian population of flesh-footed shearwaters, which breeds at only one site, Lord Howe Island. Observed bycatch rates for flesh-footed shearwaters were 0.378 birds/1000 hooks for night sets, and 0.945 birds/ 1000 hooks for day sets. The mean number of birds killed from 1998 to 2002 was estimated to be 1794–4486 birds per year, with the estimated total killed over this period ranging from 8972 to 18,490 birds. Models incorporating both density-independent and density-dependent scenarios were applied to levels of bycatch representative of that observed in the fishery. Density-independent scenarios showed that fishing mortality levels caused declines in the majority of simulated populations. In contrast, density-dependent scenarios produced populations that were more resilient to fishing mortalities. Although some modelling scenarios led to population growth, under most stochastic simulations median population halving and quasi-extinction times were less than 55 and 120 years, respectively. We conclude that the level of bycatch observed in the fishery is most likely unsustainable and threatens the survival of the Lord Howe Island population. This situation can be improved only with the development and implementation of mitigation measures that will halt or greatly reduce the level of bycatch currently observed. Improved knowledge on a range of demographic parameters for the species, combined with a clearer idea of the at-sea distribution of breeding and non-breeding shearwaters, will greatly assist in improving understanding and

the management of this population.

(Agenda Item 5.1)

Information Documents

CCSBT-ERS/0602/Info 01

National Plan of Action for the Conservation and Management of Sharks – Australia

McLoughlin, K. and Bensley, N.

ABSTRACT

The Australian Department of Agriculture, Fisheries and Forestry (DAFF) coordinated the national implementation of the International Plan of Action for the Conservation and Management of Sharks and the development of Australia's National Plan of Action (Shark-plan). The Shark-plan was developed by a Shark Advisory Group comprising of representatives from: relevant Australian Government and State and Territory agencies; the commercial fishing industry; recreational fishing groups; indigenous groups; scientific agencies and conservation groups. The Shark-plan recognises that while Australia is not a major shark fishing nation, sharks are an important part of the total quantity of Australia's wild fish production and that Australian vessels regularly take sharks as target and non-target catch. Australia's Shark-plan was formally endorsed and released in April 2004. The plan identifies 43 actions to improve conservation and management of Australia's shark stocks.

(Agenda Item 5.1)

CCSBT-ERS/0602/Info 02

The implementation of the National Plan of Action for the Conservation and Management of Sharks – Australia

McLoughlin, K. and Bensley, N.

ABSTRACT

The Shark-plan Implementation and Review Committee (SIRC) was established in 2004 to oversee the implementation of Australia's *National Plan of Action for the Conservation and Management of Sharks (Shark-plan)*. Four regional operational plans are being developed to facilitate the implementation of the Shark-plan.

The SIRC membership includes one representative from each State and the Northern Territory fisheries agencies, and members of the Australian Government Departments of Agriculture, Fisheries and Forestry (including the Bureau of Rural Sciences), Environment and Heritage, and the Australian Fisheries Management Authority. The SIRC is a co-ordinating committee with the role of monitoring Shark-plan actions and ensuring that commitments are met.

The Shark-plan is not intended to be overly prescriptive about how responsibilities under the Shark-plan are met and provides guidance and advice on how Shark-plan actions can be integrated into fisheries and conservation management arrangements for target and non-target shark species. The cooperation of stakeholders will be a critical determinant of the Shark-plan's success.

(Agenda Item 5.1)

CCSBT-ERS/0602/Info 03

The analysis of AFMA seabird mitigation trials – 2001 to 2004

Lawrence, E., Wise, B., Bromhead, D., Hindmarsh, S., Barry, S. and Findlay, J.

ABSTRACT

The incidental catch of seabirds by pelagic longline in Australia's Eastern Tuna and Billfish longline Fishery (ETBF) is an issue of ongoing concern. Three mitigation trials (employing tori poles, gear weighting, underwater setting chutes) have been conducted over the past 5 years. None have been successful in reducing catch rates below initial 0.05/1000 hooks limit rate. This paper presents results from statistical modelling which was used to identify those factors influencing both interactions and captures of seabirds by longliners. While analyses were hindered by limitations in the available data, a number of key findings and recommendations are put forth. The use of night setting, tori poles and dead baits (during the day) significantly reduced catch rates of seabirds and offers some potential for development of management options. A number of other factors were also found to be related to seabird catch rates. Seabird catches and interactions are higher where seabird abundance is higher, suggesting that spatial restrictions on fishing might be considered to reduce the likelihood of vessels encountering high abundance times and areas. It was also clear that there is a seasonal effect, with spring being the period of highest catches and winter the lowest. A more detailed spatial/seasonal analyses of captures could offer fishery managers some spatio-temporal management options (i.e. in the form of closed time-areas). Analyses should be re-run and updated as further data becomes available.

(Agenda Item 5.1)

CCSBT-ERS/0602/Info 04

Implementation of Australia's Threat Abatement Plan for the Incidental Catch of Seabirds During Oceanic Longline Fishing Operations

Baker, G.B. and Schubert, M.

ABSTRACT

This paper describes the development and implementation of Australia's key policy document to address the impact of longline bycatch of seabirds, the Threat Abatement Plan (TAP), since it was finalised in 1998. The implementation of the TAP has been reviewed and a revised draft TAP 2006 is expected to enter into force within the next few months.

Since the TAP came into effect significant progress has been made in mitigating seabird bycatch. Night-setting of longlines and the use of bird scaring lines is now mandatory in high risk areas, and development and trialing of new mitigation measures has been undertaken over the last three years. A number of fisheries have recorded incidental catch rates well below the maximum permissible rate of 0.05 birds per 1000 hooks. However, for some pelagic fisheries it has become clear that another approach is needed to assist fisheries to achieve the target. The revised TAP, rather than prescribing mandatory mitigation measures as before, sets the performance indicators for each fishery and requires fishery managers and the fishing industry to adopt 'proven mitigation measures' to achieve this. Failure to achieve the performance indicator will require the adoption of a defined management response to reduce bycatch to the specified level, and ultimately closure of all or part of a fishery if revised management approaches are not successful.

This information is provided to assist the Commission in the further development and implementation of bycatch mitigation measures.

CCSBT-ERS/0602/Infor 06

**Analysis of albatross and petrel distribution within the CCSBT area: results from the Global *Procellariiform* Tracking Database
BirdLife International**

ABSTRACT

This paper presents an analysis of the spatial overlap between albatross and petrel distribution and CCSBT fishing effort, using data from the Global *Procellariiform* Tracking Database and CCSBT's public domain catch and effort data.

The results demonstrate that there is high potential for interaction between breeding albatross and petrel and fisheries in the CCSBT area: the area overlaps with 56% of Southern Hemisphere breeding albatross distribution and 23% of available petrel distribution data. The breeding distributions of nine species of albatross overlap with the CCSBT area by over 70%. Results also indicate that the non-breeding distributions of a further two species overlap significantly with the CCSBT area.

Distribution data indicate that albatross and petrel ranges extend almost throughout the CCSBT area, but clusters of high density indicate areas where the potential risk of bycatch is high. This is borne out by data from Japan's Real Time Monitoring Program (RTMP), which also suggest that non-breeding birds make up a significant proportion of the bycatch in the region. The degree of overlap between the CCSBT area and albatross and petrel ranges is therefore greater than the 56% suggested by the breeding albatross distribution.

Data from Japan's RTMP demonstrates the importance of reporting location and date of seabird bycatch data, since the clustered nature of albatross distribution means bycatch rates need to be standardised by seabird abundance in some way: low seabird bycatch rates in areas of high seabird abundance have a very different meaning to low seabird bycatch rates in areas of low seabird abundance. Date and location of observer data can be related to seabird density distribution maps, such as those provided by the Global *Procellariiform* Tracking Database, and these data can then provide real insights into rates and risks of bycatch. More thorough scientific reporting of observer data, and agreement within CCSBT of standardised reporting methods are crucial given the importance of the CCSBT area for the survival of these vulnerable species. The tracking data also emphasise the great need for seabird bycatch data from Taiwanese vessels, whose distributions differ from those of Japanese vessels.

(Agenda Item 5.1)

CCSBT-ERS/0602/Info 07

Incidental Mortality of Mammals and Seabirds Associated with Fishing (Extract from the Report of the ad hoc WG-IMAF to CCAMLR-XXIV: RFMOs, Tuna Commissions and International Governmental organisations)

CCAMLR Ad hoc Working Group – Incidental Mortality Associated with Fishing

SUMMARY

In 2004 CCAMLR, adopted a resolution to request relevant Regional Fisheries Management Organisations (RFMOs) to implement and develop mechanisms for collecting, reporting and disseminating data on seabird incidental mortality (Resolution 22/XXIII). The ad-hoc WG-IMAF also expressed concern at the levels and rates of seabird (especially albatross) by-catch in the CCSBT fisheries, where the total annual mortality of seabirds could approach, or even exceed,

13 500 seabirds including about 10 000 albatrosses. The Working Group, while acknowledging the very approximate nature of these estimates and the substantial extrapolations involved, viewed these numbers with substantial concern. It re-emphasised the need for effective mitigation of seabird by-catch, not simply confined to the mandatory use of streamer lines but involving some combination of improved line weighting, night setting and offal management. Evaluation of the effectiveness of the improved mitigation, together with acquiring better estimates of seabird by-catch levels and rates, would require a more extensive and detailed program of data collection by observers.

The Working Group also noted that the 26th Session of COFI (March 2005) had expressed strong support for a proposal by Japan that, with FAO technical cooperation, Japan and possibly other sponsors convene a joint meeting of the secretariats of the tuna RFMOs and their members, to be held in 2007. The Working Group noted that the provisional agenda for the meeting includes reviewing incidental catch-related measures and could be a valuable opportunity to explore implementation of consistent best-practice provisions for collection, analysis and dissemination of by-catch data, together with improved implementation of mitigation measures appropriate to the areas, times and target species involved.

(Agenda Item 5.1)

Attachment 1

Australian Fisheries
Management Authority.
Commonwealth of Australia

Australian Purse Seine and Pole Daily Fishing Log - For Farmed Southern Bluefin Tuna Only TPB03

Log Book No: 0026	Page No: 02	Boat Name: <i>Sea Spray</i>	Dist. Symbol: <i>LFB 12345</i>	Master's Name: <i>C. Gavin</i>
-----------------------------	-----------------------	--------------------------------	-----------------------------------	-----------------------------------

TICK APPROPRIATE NON-FISHING (NF) CODE BOX AT RIGHT: 1 Bad Weather 2 In Port 3 Broken Down 7 Cage Towing Fishing Method Used? (tick appropriate box) Poling Purse Seining

I did not work between *..28/..5/..98..* and *..28/..11/..98..* 4 Steaming 10 Refit Distinguishing Nos. of assisting vessels NB: State whether pole or seine boats *LFB023 (pole boat)*

Date of Fishing	NF Code?	Search Details			Fishing Details						Total Weight and Type of Bait		Estimated Catch Weights per Shot (kg)				Towing					
		Date (day/month)	Codes listed above	Hours Searched	Spotter Plane Used? (Y/N)	Sea Surface Temp. (C)	Start Time (24hr) (local time)	Latitude	Longitude	No. Poles Used?	Pole Boat Assisted Y/N	Seine Boat Assisted Y/N	Type	Kgs	SBT Weight	Other Species	Other Weight	Estimated % of school caught	Carrier Boat Name	Weight Transferred	Transfer Date	SBT 03
																					Book No.	Page No.
<i>29/11</i>	<i>6</i>		<i>4</i>	<i>20</i>	<i>1300</i>	<i>32°40'</i>	<i>132°30'</i>		<i>4</i>					<i>8,000</i>	<i>-</i>	<i>-</i>	<i>90</i>	<i>Star</i>	<i>8,000</i>	<i>29/11</i>	<i>036</i>	<i>09</i>
<i>30/11</i>	<i>4</i>																					
<i>1/12</i>		<i>4</i>	<i>N</i>	<i>21</i>	<i>1200</i>	<i>34°05'</i>	<i>131°08'</i>		<i>4</i>					<i>15,000</i>	<i>-</i>	<i>-</i>	<i>95</i>	<i>Jane S.</i>	<i>15,000</i>	<i>1/12</i>	<i>024</i>	<i>36</i>
<i>2/12</i>		<i>5</i>	<i>4</i>	<i>19</i>	<i>1100</i>	<i>33°50'</i>	<i>131°20'</i>		<i>N</i>					<i>25,000</i>	<i>-</i>	<i>-</i>	<i>70</i>	<i>"</i>	<i>25,000</i>	<i>2/12</i>	<i>024</i>	<i>36</i>
<i>2/12</i>		<i>2</i>	<i>4</i>	<i>19</i>	<i>1600</i>	<i>33°54'</i>	<i>131°17'</i>		<i>4</i>					<i>12,000</i>	<i>-</i>	<i>-</i>	<i>80</i>	<i>"</i>	<i>12,000</i>	<i>2/12</i>	<i>024</i>	<i>36</i>

Comments:

Wildlife Interactions:
List any wildlife interacting with you during your fishing activities, including netted animals. If possible, list Species name, Interaction Date, No. of Animals and Life Status of any animals released after capture. Life Status Codes are listed on the writing template. Please record any extra details in the Comments section.

Species:	Date/s:	Qty:	Life Status:

Concession Holder or Authorised Person:
I certify that the information I have provided on this form is a complete and accurate record.

Dated: *3/12/98*

Name: **C. GAVIN**

Signature: *C. Gavin*

Attachment 2

Australian Pelagic Longline Daily Fishing Log – AL05

Australian Fisheries Management Authority.
Box 7051
Canberra Mail Centre ACT 2610

NOTE: DO NOT USE A SINGLE PAGE FOR MORE THAN ONE TRIP

Original Copy – Send to AFMA

Log No.	Page No.	Boat Name Cormorant	Dist. Symbol LFB963	Time Zone Fished EST	Departure Port ULLADULLA	Departure Date 12/6/00									
SHOT INFORMATION		Shot 1 Date 13/6/02	Shot 2 Date 15/6/02	Vessel docked between 9 / 6 / 02 and 11 / 6 / 02											
Start Set Time (24h)		0300	0230	Non-fishing Date/s and Codes during a Trip (ENTER CODE IN BOX)											
Start Set	Lat. (dd mm)	35 35	36 31	1 – Bad Weather 3 – Broken Down 4 – Steaming											
Position	Long. (ddd mm)	151 42	151 55	6 – Searching 5 – Other Fishery (SPECIFY)											
End Set Time (24h)		0610	0515	Date/s											
End Set	Lat. (dd mm)	35 19	36 25	12 / 6 / 02 to / /											
Position	Long. (ddd mm)	151 40	151 40	14 / 6 / 02 to / /											
Mainline Length No. hooks		35 nm(km) 900 hooks	27 nm(km) 800 hooks	Code											
Line shooter used (CIRCLE)		<input checked="" type="radio"/> Yes <input type="radio"/> No	<input checked="" type="radio"/> Yes <input type="radio"/> No	4											
Seabird Mitigation Measures Used (CIRCLE)		<input checked="" type="radio"/> TORI <input checked="" type="radio"/> THAW <input type="radio"/> PSBL <input checked="" type="radio"/> NSET <input type="radio"/> LWEI <small>CHUTE CAPS DYED OTHER NAPP</small>	<input checked="" type="radio"/> TORI <input checked="" type="radio"/> THAW <input type="radio"/> PSBL <input checked="" type="radio"/> NSET <input type="radio"/> LWEI <small>CHUTE CAPS DYED OTHER NAPP</small>	6											
Gear Information	Estimated average depth targeted in metres		80	70	Comments										
	No. hooks between bubbles		9	10	Snood cut to release large, lively blue marlin. Discards refer to fish not sought by market.										
	No. of lightsticks used		300	400											
	Bait type/wt used for shot		Squid/Pilchards 200 kg	Pilchards 160 kg											
	Bought <input checked="" type="checkbox"/> Self caught <input type="checkbox"/>		Live bait <input type="checkbox"/> Dead bait <input checked="" type="checkbox"/>	Live bait <input type="checkbox"/> Dead bait <input checked="" type="checkbox"/>											
	Sea surface temp. (C)		17	18											
	Wind direction (ie. NW)		S	SSE											
Wind speed (kn)		12	15												
		Start Set	End Set	Start Set	End Set	Minor Line Methods Used									
		17	18	16	16	Trolling <input checked="" type="checkbox"/> Hrs 2									
		S	SSE	SW	WSW	Rod & Reel <input type="checkbox"/> Hrs									
		12	15	8	12	Handline <input type="checkbox"/> Hrs									
						No. of Lines Used? 2									
Catch Details Tick box below to show target species		No. Fish Kept	Est. Processed Wt Kept (kg)	Form Code	No. Fish Not Kept	No. Fish Kept	Est. Processed Wt Kept (kg)	Form Code	No. Fish Not Kept	No. Fish Kept	Est. Processed Wt Kept (kg)	Form Code	No. Fish Not Kept	Complete at End of Trip	
Yellowfin Tuna <input checked="" type="checkbox"/>		11	350	GG	3	14	480	GG	1	3	60	GG		Port of Landing	
Bigeye Tuna <input checked="" type="checkbox"/>		4	150	GG		6	160	GG						ULLADULLA	
Albacore <input type="checkbox"/>		7	50	W		4	40	W		2	15	W		Trip End Date	
Southern Bluefin Tuna <input type="checkbox"/>														15/6/00	
Broadbill Swordfish <input type="checkbox"/>						2	90	TR						First Receiver/s of Fish	
Striped Marlin <input type="checkbox"/>		1	35	TR										ULLADULLA CO-OP	
Ray's Bream <input type="checkbox"/>					2	3	10	GG						See writing template for a list of FORM CODES – to be entered with each shot.	
Northern 'Jumbo' Bluefin Tuna <input type="checkbox"/>														MITIGATION MEASURES CODES TORI = bird scaring line & pole THAW = thawed bait PSBL = punctured swim bladder (Bait) NSET = night setting LWEI = line weighting (branch line) CHUTE = under-water setting chute CAPS = under-water setting capsule DYED = dyed bait OTHER = please describe in comments section, eg. bait casting machine NAPP = eg. fishing north of 30°, or caught during haul	
Short Finned Mako Shark <input type="checkbox"/>		1	80	F					1						
Bronze Whaler Shark <input type="checkbox"/>															
Dusky Whaler Shark <input type="checkbox"/>															
Blue Shark <input type="checkbox"/>					7				4						
Oceanic Whitetip Shark <input type="checkbox"/>															
Blacktip Shark <input type="checkbox"/>															
Tiger Shark <input type="checkbox"/>															
Hammerhead Shark <input type="checkbox"/>															
Silky Shark <input type="checkbox"/>															
Porbeagle Shark <input type="checkbox"/>		2	90	TR											
Rudderfish <input type="checkbox"/>		2	10	GG		1	30	TR							
Oilfish <input type="checkbox"/>						1	4	GG							
Escolar (Black Oilfish) <input type="checkbox"/>		3	25	GG											
Dolphinfish <input type="checkbox"/>									1						
Wahoo <input checked="" type="checkbox"/> Sunfish					1										
Lancetfish <input type="checkbox"/>					3										
Other Species		Moonfish							2						
		Thresher Shark		1	50	TR	1	10	F						
No Take Species		Species		Number Released		Number Released		Number Released		Number Released		Number Released		Please provide an estimate of the time taken to complete this form 12 mins	
				Alive	Dead	Alive	Dead	Alive	Dead	Alive	Dead	Alive	Dead		
		Blue Marlin		1											
		Black Marlin													
Great White Shark															
Grey Nurse Shark															
Non-Fish Bycatch / Interactions		Shot No.	Species Group eg. seabird, cetacean, turtle OR Species (if known)	No. Released		Position Caught		No. Caught During		Estimated Time of					
				Alive	Dead	Lat. (dd mm) / Long. (ddd mm)	Set	Haul	Interaction						
		1	Loggerhead Turtle	1		35° 24'S 151° 41'E	N/A		N/A						
2	Albatross		1	36° 29'S 151° 52'E	1		0700								
COMMENTS – Is there anything else that you consider to be important? eg. gear failure, tag or band numbers, was the animal hooked or entangled, etc.															
Shot No. 2 . Hooked in beak - Bird drowned, carcass discarded. Band no. and further details recorded on Tag Form. Photos provided with logsheets. Turtle released alive, trace cur at hook.															
Tag <input checked="" type="checkbox"/> Band No. A754L															

I certify the information which I have provided on this form to be a complete and accurate record.

Concession Holder or Authorised Person	Printed Name TIM GARDENER	Signature <i>T. Gardener</i>	Date 15 / 6 / 02
--	----------------------------------	------------------------------	-------------------------

NOTE • If tagged fish / animals or banded birds are captured, please complete tag form at back of book and return to AFMA.

Attachment 3

PT02 Form

Commonwealth Catch Disposal Record – PT02

Book No.	Page No.

Part A - Concession holder or authorised representative to complete

Boat Name **Debbie Jane** Distinguishing Symbol **LFB123** Fishery SPF WTBF High Seas

Concession Holder's Name **Johnathon Janson** Name of transporter **Wally's Trucking**

Method **LONGLINE** Method used to determine accurate wt. **No. of bins** Type of Vehicle **FORD TRUCK**

Permit/SFR No. **12345A** Vehicle Reg. No. **UFT-312**

Duration of Trip From **17 / 6 / 04** To **23 / 6 / 04** Total accurate weight of consignment **14,700** Circle no. of Vehicles Including this one 1 2 3 4 5

Date & time of unloading **23 / 6 / 04 18:00** Total no. of bins/boxes consigned **25** Note: If more than one vehicle is used to transport this catch a separate transit form must be completed and sent with each load.

Port of unloading **ALBANY** Whole/Part of Catch W P Date & time consignment left from point of unloading **23 / 6 / 04 19:00**

Receiver consignment sent to **JOE'S FISH SUPPLIES** Recording daily catch and effort log book and page numbers

Book No. Page No.s Book No. Page No.s

1399 From **2** To **8** From To *Please provide an estimate of the time taken to complete this form: hrs **20** mins

Part B - Concession holder or authorised representative to complete

SPECIES	Code	Kilos of Fish (accurate weight)	Form Code	Carcass No.
Broad Billed Swordfish	BBL	7 0 0 0	H G	1 1 4
Yellowfin Tuna	YFT	3 0 0 0	G G	1 4 0
Bigeye Tuna	BET	2 0 0 0	G G	4 0
Striped Marlin	STM			
Albacore	ALT	5 0 0 W		
Longtail Tuna	LTT			
Ray's Bream	POM			
Skipjack Tuna	SKT			
Rudderfish	RUD			
Escolar (Black Oilfish)	BOF			
Moonfish	OPA			
Wahoo	WAH			
Oilfish	OIL			
Dolphinfish	DOL	2 0 0 0 W		
Lancet Fish	LAN			
Shark Species				
Blue Shark	TR	2 0 0		4
Crocodile Shark	CSH			
Short Finned Mako	SFM			
Hammerhead Shark	SPN			
Oceanic Whitetip Shark	OWS			
Tiger Shark	TSM			
Silky Shark	SKS			
Portbeagle	POR			
Blacktip Shark	TIP			
Thresher Shark	TSR			
Other Species				

Instructions for Fishers

More detailed instructions are located on the front of the writing template.

When completing Parts A and B of this form:

- Recording daily catch and effort logbook book and page numbers:** Record the book and page numbers for this trip, eg if you completed pages 1, 2 and 3 of Logbook 1234, in the space above enter Book No. 1234, Page No.s from 1 to 3. If you use more than one logbook, enter the numbers in the separate boxes.
- Lodging forms:** Fishers, after completing this form -
 - lodge the white copy with AFMA within **24 hours** of unloading
 - leave green copy in this book
 - send the blue and yellow copies with the fish to the receiver of the fish
- Form code - a form code MUST BE entered for each species.**

Form Codes:
Tuna-like species and Scalegfish:
GG = gilled and gutted, W = whole, G = gutted, HG = headed and gutted

Warning to Fishers

An infringement notice may be issued or other prosecution action taken if the concession holder or authorised representative fails to complete and lodge this form in accordance with the instructions.

*In line with government policy all Commonwealth forms to be completed by small business must include a time box indicating the length of time the form took to complete.

Comments: **Take Home 10kg Dolphinfish**

I certify that I have completed the information required in accordance with the instructions and that this information is a complete and accurate record.

Printed name of authorised representative completing form Printed name of driver

Signature of authorised representative completing form Signature of driver

Date / / Date / /

Attachment 4

Wildlife and Other Protected Species List

Please be as specific as you can with regard to the species identification.

Fish Species	
Great White Shark	<i>Carcharodon carcharias</i>
Grey Nurse Shark	<i>Carcharias taurus</i>
Whale Shark	<i>Rhincodon typus</i>
Pipefish, Sea Horses & Sea Dragons	<i>Syngnathids</i>
Black Cod	<i>Epinephelus daemlii</i>

Non-Fish			
All Seabirds	All Seals	All Whales/Dolphin/Dugong	Marine Reptiles
Albatross	Australian Sea Lion	Dolphin (<i>if species unknown</i>)	Flatback Turtle
Booby	Australian Fur Seal	Killer Whale	Green Turtle
Cormorant	New Zealand Fur Seal	False Killer Whale	Hawksbill Turtle
Frigatebird	Fur Seal (<i>if species unknown</i>)	Humpback Whale	Leatherback Turtle
Gannet	Leopard Seal	Pilot Whale	Loggerhead Turtle
Giant Petrel	Southern Elephant Seal	Sperm Whale	Olive Ridley Turtle
Gull		Southern Right Whale	Turtle (<i>if species unknown</i>)
Mollymawk		Baleen Whale (<i>if species unknown</i>)	Sea Snake
Mutton Bird		Toothed Whale (<i>if species unknown</i>)	
Noddy		Large Whale (<i>if species unknown</i>)	
Pelican		Small Whale (<i>if species unknown</i>)	
Penguin		Dugong	
Petrel			
Prion			
Shag			
Skua			
Shearwater (Mutton bird)			
Tern			
Tropicbird			
Large Seabird			
Small Seabird			

Common Names for Albatross, Petrels and Other Seabird Species

Great Albatross	Mollymawks and Sootys	Petrels	Others
Wandering Albatross	Black-browed Albatross	Northern Giant Petrel	Abbot's Booby
Northern Royal Albatross	Campbell Albatross	Southern Giant Petrel	Lesser Noddy
Southern Royal Albatross	Buller's Albatross	White-chinned Petrel	Christmas Island Frigate
Gibson Albatross	Shy Albatross		
Antipodean Albatross	White-capped Albatross		
Tristan Albatross	Salvin's Albatross		
Amsterdam Albatross	Chatham Albatross		
Laysan Albatross	Grey-headed Albatross		
Yellow-nosed	Albatross (Indian)		
Light-mantled Albatross			
Sooty Albatross			

Attachment 5

Recapture Sheets for all Tagged Fish, Tagged Animals and Banded Seabirds

When you catch any tagged fish or other animals, or banded birds, please complete the questionnaire below and forward it to:

AFMA Logbook Coordinator
Box 7051
Canberra MC ACT 2610

If you have any comments to make about the captured fish/animal or this questionnaire, use the reverse of this sheet.

Please Note: There are rewards for many of the Tagging Programs currently being undertaken.

The Green copy of this tag recapture sheet is for your own records.

Please return the tag/tags with this form.

Name, Address and Phone No.					
Skipper's Name			Vessel Name		
Tag Number/s and colour			Capture Date		
Length of fish - from tip of lower jaw to fork in tail or for Swordfish from behind eyeball to fork in tail			cm	Estimated Whole Weight of Fish	kg
Location of capture of tagged fish Latitude (dd mm)			Longitude (ddd mm)		
Number of tags recovered from this fish (tick one) 1 <input type="checkbox"/> 2 <input type="checkbox"/>			Species		

Name, Address and Phone No.					
Skipper's Name			Vessel Name		
Tag Number/s and colour			Capture Date		
Length of fish - from tip of lower jaw to fork in tail or for Swordfish from behind eyeball to fork in tail			cm	Estimated Whole Weight of Fish	kg
Location of capture of tagged fish Latitude (dd mm)			Longitude (ddd mm)		
Number of tags recovered from this fish (tick one) 1 <input type="checkbox"/> 2 <input type="checkbox"/>			Species		

Name, Address and Phone No.					
Skipper's Name			Vessel Name		
Tag Number/s and colour			Capture Date		
Length of fish - from tip of lower jaw to fork in tail or for Swordfish from behind eyeball to fork in tail			cm	Estimated Whole Weight of Fish	kg
Location of capture of tagged fish Latitude (dd mm)			Longitude (ddd mm)		
Number of tags recovered from this fish (tick one) 1 <input type="checkbox"/> 2 <input type="checkbox"/>			Species		

Attachment 6

Recapture Sheets for all Tagged Fish/Animal Recaptures

When you catch any tagged fish (or other animals) please complete the questionnaire below, and forward it with the tag/s to:

**The Logbook Coordinator
Australian Fisheries Management Authority
Box 7051
Canberra Mail Centre
ACT 2610**

If you have any comments to make about the captured fish/animal, this questionnaire, or any other matter use the reverse of this sheet.
PLEASE NOTE: THERE ARE REWARDS FOR TAG RETURNS IN MANY OF THE TAGGING PROGRAMS CURRENTLY BEING UNDERTAKEN!

The **BLUE COPY** of this form is for your own records.

Name and Address	-----			
Skipper's Name		Vessel Name		
Tag Number		Capture Date		
Length of fish - from tip of lower jaw to fork in tail		cm	Weight of Fish Whole / Cleaned	
Location of capture of tagged fish (degrees and minutes)	Latitude		Longitude	
Number of tags recovered from this fish (tick one) 1 <input type="checkbox"/> 2 <input type="checkbox"/> Species				

Name and Address	-----			
Skipper's Name		Vessel Name		
Tag Number		Capture Date		
Length of fish - from tip of lower jaw to fork in tail		cm	Weight of Fish Whole / Cleaned	
Location of capture of tagged fish (degrees and minutes)	Latitude		Longitude	
Number of tags recovered from this fish (tick one) 1 <input type="checkbox"/> 2 <input type="checkbox"/> Species				

Name and Address	-----			
Skipper's Name		Vessel Name		
Tag Number		Capture Date		
Length of fish - from tip of lower jaw to fork in tail		cm	Weight of Fish Whole / Cleaned	
Location of capture of tagged fish (degrees and minutes)	Latitude		Longitude	
Number of tags recovered from this fish (tick one) 1 <input type="checkbox"/> 2 <input type="checkbox"/> Species				

Attachment 7

VESSEL VOYAGE SUMMARY



OBSERVER DETAILS

OBSERVER LAST NAME	JOE SON
OBSERVER FIRST NAME	ANDY
OBSERVER PROJECT	TORI LINE
OBSERVER TRIP ID No	VL 14
EMPLOYING ORGANISATION	AFMA

TIME ZONE

Record in this field the time zone that you have used when recording data on this voyage. You should use ship's time, which may not be local time. Use only one time zone per voyage.

UTC + 10

VOYAGE DETAILS

DEPARTURE (SHIP DATE AND TIME)

DD	MM	YY	hh	mm
23	04	03	05	00

RETURN (SHIP DATE AND TIME)

DD	MM	YY	hh	mm
24	04	03	17	00

DEPARTURE TYPE

(circle)

PORT OR VESSEL NAME

PORT

NAROOMA

TRANSFER

RETURN TYPE

(circle)

PORT OR VESSEL NAME

PORT

NAROOMA

TRANSFER

ACTIVITY SUMMARY

TOTAL No OF HOOKS, TRAPS OR NETS SET	800
TOTAL No OF HOOKS, TRAPS OR NETS OBSERVED	800
TOTAL No OF SETS (HOOK FISHERY ONLY)	1
TOTAL No OF SETS OBSERVED (HOOK FISHERY ONLY)	1
TOTAL No OF HAULS OBSERVED	1
TOTAL No OF BIOLOGICAL DATA SHEETS	3
TOTAL No OF WILDLIFE ABUNDANCE DATA SHEETS	2
TOTAL No OF WILDLIFE INTERACTION DATA SHEETS	2
TOTAL No OF SAMPLES RETAINED	0
TOTAL No OF SEABIRDS CAUGHT	0

TOTAL No OF BIRD BANDS COLLECTED	0
TOTAL No OF FISH TAGS COLLECTED	1
TOTAL No OF DAYS ABOARD	2
TOTAL No OF FISHING DAYS	2
TOTAL No OF STEAMING DAYS	0
TOTAL No OF SEARCHING DAYS	0
TOTAL No OF DAYS LOST TO BREAKDOWN	0
TOTAL No OF DAYS LOST TO WEATHER	0
TOTAL No OF FISH, BIRDS OR SEALS TAGGED	0
TOTAL No OF SEALS CAUGHT	0
TOTAL No OF CETACEANS CAUGHT	0

WILDLIFE MITIGATION MEASURES

WERE WILDLIFE MITIGATION MEASURES DEPLOYED DURING THE CRUISE (Y/N)	Y
TYPE OF WILDLIFE MITIGATION MEASURES DEPLOYED	TORI LINE
TOTAL No OF HOOKS, TRAPS OR NETS SET WITH WILDLIFE MITIGATION MEASURES DEPLOYED	800
TOTAL No OF HOOKS, TRAPS OR NETS SET WITHOUT WILDLIFE MITIGATION MEASURES DEPLOYED	0

TAG & BAND DETAILS

TAG or BAND NUMBER	N 56781	N 72181
TAG ACTION (CAPTURED or RE-RELEASED)	CAPTURED	CAPTURED
OBSERVER ONBOARD @ TIME OF CAPTURE (Y/N)	Y	N
TAG / BAND AGENCY	NSW FISH	NSW FISH
TAG / BAND TYPE	Spagettie	Spagettie
TAG / BAND COLOUR	Yellow	Yellow
SPECIES CODE	YFT	MLS
DATE OF CAPTURE (DD/MM/YY)	23/04/03	07/08/02
LATITUDE	36°00.6	36°01.7
LONGITUDE	150°51.7	150°51.7
LENGTH LCF (cm)	120	900
WHOLE WEIGHT (kgs)	30	170
SST (°C)	21.7	23.7
MARKING COLOUR		
MARKING POSITION		
OBSERVED AGAIN (Y/N)		
COMMENTS		See below

COMMENTS

A yellow NSW gamefish tag was given to the observer during the steaming home. The strip's details for a reward are as follows:

Name Mark Smith
Address 17 Altair Place
Narooma 2617

Attachment 7



OBSERVER PROGRAMME

TORI POLE AND LINE SPECIFICATIONS

OBSERVER NAME	ANDY JOESON	OBSERVER TRIP ID	VI 14
VESSEL NAME	VIXEN	OBSERVER PROJECT	TORI LINE 38gram

TORI POLE - PORT

(1) TORI POLE LENGTH (METERS)	5
(2) CONSTRUCTION MATERIAL	AL
(3) POLE ANGLE (DEGREES)	80
(4) DISTANCE OF POLE FROM STERN (METERS)	9
(5) HEIGHT OF TIP OF POLE ABOVE DECK (METERS)	5
(6) HEIGHT OF TIP OF POLE ABOVE WATER (METERS)	6
(7) HEIGHT OF TORI LINE AT POINT ABOVE STERN (M)	3

TORI POLE - STARBOARD

(1) TORI POLE LENGTH (METERS)	5
(2) CONSTRUCTION MATERIAL	AL
(3) POLE ANGLE (DEGREES)	80
(4) DISTANCE OF POLE FROM STERN (METERS)	9
(5) HEIGHT OF TIP OF POLE ABOVE DECK (METERS)	5
(6) HEIGHT OF TIP OF POLE ABOVE WATER (METERS)	6
(7) HEIGHT OF TORI LINE AT POINT ABOVE STERN (M)	3

TORI LINE - PORT

(8) TOTAL LENGTH OF TORI LINE (METERS)	200	
(9) LENGTH OF AERIAL SECTION (METERS)	100	
(10) LENGTH OF WATER SECTION (METERS)	100	
AERIAL SECTION	MATERIAL	KV
	DIAM (MM)	5
	COLOUR	Yellow
WATER SECTION	MATERIAL	KV
	DIAM (MM)	5
	COLOUR	Red

TORI LINE - STARBOARD

(8) TOTAL LENGTH OF TORI LINE (METERS)	200	
(9) LENGTH OF AERIAL SECTION (METERS)	100	
(10) LENGTH OF WATER SECTION (METERS)	100	
AERIAL SECTION	MATERIAL	KV
	DIAM (MM)	5
	COLOUR	Yellow
WATER SECTION	MATERIAL	KV
	DIAM (MM)	5
	COLOUR	Red

STREAMER DESCRIPTION - PORT

NUMBER OF STREAMERS	30
(11) AVERAGE DISTANCE APART (METERS)	2
(12) AVERAGE LENGTH (METERS)	2
LENGTH FIXED (fix) OR VARIABLE (var)	Fix
SAME HEIGHT ABOVE WATER (Y/N)	N
PAIRED (p), SINGLE (s), COMBINATION (c)	Paired
LENGTH TYPE - (FIXED, DETACHABLE, COMBINATION)	Fix
MATERIAL	Packings strip
DIAM (MM)	20
COLOUR	Blue

STREAMER DESCRIPTION - STARBOARD

NUMBER OF STREAMERS	30
(11) AVERAGE DISTANCE APART (METERS)	2
(12) AVERAGE LENGTH (METERS)	2
LENGTH FIXED (fix) OR VARIABLE (var)	Fix
SAME HEIGHT ABOVE WATER (Y/N)	N
PAIRED (p), SINGLE (s), COMBINATION (c)	Paired
LENGTH TYPE - (FIXED, DETACHABLE, COMBINATION)	Fix
MATERIAL	Packings strip
DIAM (MM)	20
COLOUR	Blue

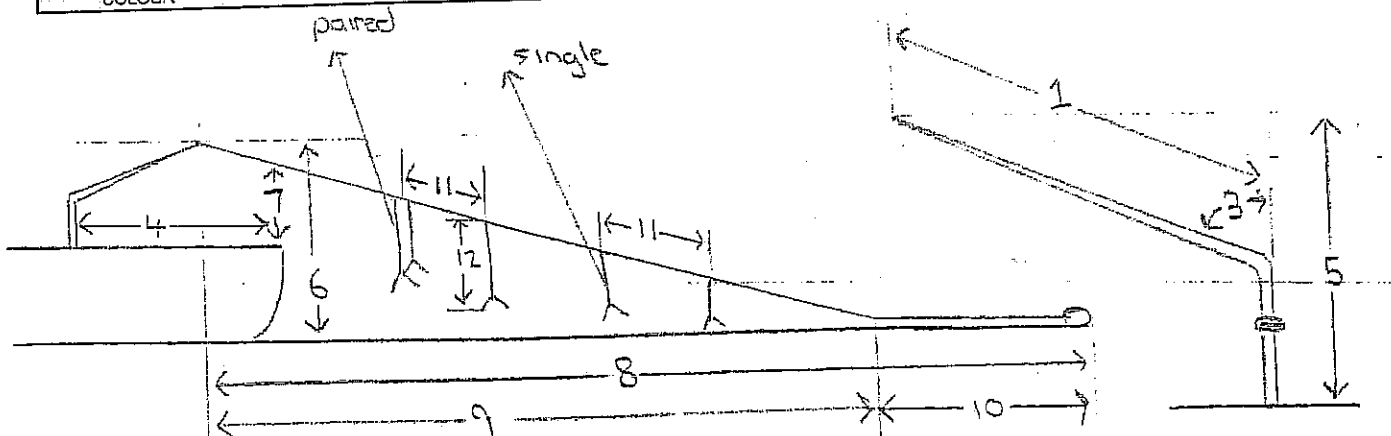

COMMENTS

Tori Lines and poles brand new. Fades were attached to the ends of tori line to keep lines tight during operations

Attachment 7

OBSERVER PROGRAMME



LONGLINE VESSEL AND FISHING GEAR DETAILS

OBSERVER NAME	ANDY JOESON	VESSEL NAME	VIXEN	OBSERVER TRIP-ID	VI 14
OBSERVER PROJECT	Tor. Line	LOG BOOK TYPE	ALO 4	LOG BOOK SERIAL No	2781

VESSEL DETAILS	
VESSEL OWNER	Mike Taggart
NATIONALITY	Australian
HOME PORT	Narooma
DISTINGUISHING SYMBOL	LFB 842
INTERNATIONAL CALL SIGN	VIXN
GROSS TONNAGE (GRT)	70
LENGTH OVERALL (LOA) metres	20.5
FREEBOARD HEIGHT (cm)	150
YEAR OF MANUFACTURE	1999
MAIN ENGINE BRAKE POWER (kw)	640
NUMBER OF MAIN ENGINES	1
FUEL CAPACITY (tonnes)	11
FUEL CONSUMPTION (tonnes / day while fishing)	0.5
TOTAL FREEZER CAPACITY (VOLUME) cm ³	21
TOTAL RSW CAPACITY (VOLUME) m ³	30
BLAST FREEZER CAPACITY (tonnes / day)	NA
COLD STORAGE CAPACITY (VOLUME) m ³	3

ELECTRONIC FISHING EQUIPMENT		
ELECTRONIC EQUIPMENT	circle	MANUFACTURER
GPS 1	<input checked="" type="radio"/> Y <input type="radio"/> N	KODEN
GPS 2	<input type="radio"/> Y <input checked="" type="radio"/> N	
RADIO DIRECTION FINDER	<input checked="" type="radio"/> Y <input type="radio"/> N	TAIYO
RADIO DIRECTION FINDER	<input type="radio"/> Y <input checked="" type="radio"/> N	
RADAR 1	<input checked="" type="radio"/> Y <input type="radio"/> N	FURUNO
RADAR 2	<input type="radio"/> Y <input checked="" type="radio"/> N	
WEATHER FACSIMILE	<input type="radio"/> Y <input checked="" type="radio"/> N	
TRACK PLOTTER	<input checked="" type="radio"/> Y <input type="radio"/> N	SEA FABER
SOUNDER 1	<input checked="" type="radio"/> Y <input type="radio"/> N	FURUNO
SOUNDER 2	<input type="radio"/> Y <input checked="" type="radio"/> N	
SONAR	<input type="radio"/> Y <input checked="" type="radio"/> N	
NOAA RECEIVER	<input checked="" type="radio"/> Y <input type="radio"/> N	TAIYO
SST RECORDER 1	<input checked="" type="radio"/> Y <input type="radio"/> N	TAIYO
SST RECORDER 2	<input type="radio"/> Y <input type="radio"/> N	
INMARSAT SERVICE	<input checked="" type="radio"/> Y <input type="radio"/> N	
VMS	<input checked="" type="radio"/> Y <input type="radio"/> N	

CREW DETAILS	
CAPTAIN'S LAST NAME	SMITH
CAPTAIN'S FIRST NAME	MARK
YEAR'S EXPERIENCE AS A CAPTAIN	4
YEARS EXPERIENCE IN THE FISHERY	13
TOTAL NUMBER OF CREW	3
OTHER	

FISHING GEAR DESCRIPTION - PART B			
BRANCHLINE CODE	BRANCHLINE A	BRANCHLINE B	BRANCHLINE C
BRANCH MATERIAL	NM		
BRANCH LENGTH (cm)	720		
SEKIYAMA MATERIAL	NA		
SEKIYAMA LENGTH (cm)	NA		
LEADER MATERIAL	NM		
LEADER LENGTH (cm)	360		
LEADER B/S (kgs)	150		
TOTAL LENGTH (cm)	870		
LEAD WEIGHT USED	Yes		
WEIGHT SIZE (gms)	38		
DISTANCE OF HOOK FROM WEIGHT (cm)	360		
HOOK TYPE (J OR CIRCLE)	Circle		
HOOK SIZE	3/0		

FISHING GEAR DESCRIPTION - PART A	
ONLINE MATERIAL	NM
MAINLINE SIZE (mm)	3.2
MAINLINE LEN (km)	60
BUOYLINE MATERIAL	KU
BUOYLINE 1 LEN (m)	10
BUOYLINE 2 LEN (m)	NA
LINE CASTING CONTROLLER	<input type="radio"/> Y <input checked="" type="radio"/> N
BRANCHLINE HAULER	<input checked="" type="radio"/> Y <input type="radio"/> N
No of BRANCHLINE HAULERS	2
LINE SHOOTER	<input checked="" type="radio"/> Y <input type="radio"/> N
TORI POLE	<input checked="" type="radio"/> Y <input type="radio"/> N
No OF TORI POLES	

COMMENTS

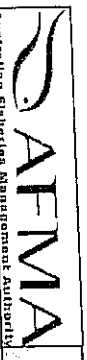

Australian Fisheries Management Authority

OBSERVER PROGRAMME

OBSERVER NAME: ANDY JOHNSON

VESSEL NAME: VIXEN

OBSERVER PROJECT: Tail Line 38

OBSERVER TRIP ID: VI 14

TIME ZONE: 10 UTC +

VESSEL ACTIVITY LOG

Date	Time (hh:mm)	Vessel Activity Code	Shot Number	Latitude (ddd° mm.m')	Longitude (ddd° mm.m')	Start End Bta #	SST °C	Net Sonde °C	Wind speed (kts)	Wind direction (d°)	Swell height (m)	Swell direction (d°)	Sea height (m)	Sea direction (d°)	Cloud / 8	Beaufort (1-12)	Vessel Course (d°)	Vessel Speed (kts)	Offal Discharge (Y/N)	Offal Discharge Level
23 Oct 03	15:30	SE	01	36 10 0.6 S	150 51 7.7 E	S 214	-	-	5	140	2	140	0.5	140	4	2	310	7	N	NA
23 Oct 03	15:44	SE	01	35 51 9.0 S	150 51 52.0 E	02 213			5	140	2	140	0.5	140	4	2	310	7	N	NA
23 Oct 03	16:12	SE	01	35 51 4.4 S	150 51 2.5 E	03 213			5	140	2	140	0.5	140	4	2	310	7	N	NA
23 Oct 03	16:55	SE	01	35 51 0.4 S	150 53 7.7 E	04 217			5	140	2	140	0.5	140	4	2	310	7	N	NA
23 Oct 03	17:40	SE	01	35 51 5.5 S	150 53 6.6 E	217			5	140	2	140	0.5	140	4	2	190	2	Y	L
23 Oct 03	06:45	HA	01	35 51 8.1 S	150 47 9.7 E	S 211			5	290	0.5	270	0.5	290	1	2	190	2	Y	L
23 Oct 03	07:18	HA	01	36 11 3.9 S	150 47 8.0 E	04 211			5	290	0.5	270	0.5	290	1	2	190	2	Y	L
23 Oct 03	09:02	HA	01	36 10 18.6 S	150 47 7.8 E	03 212			5	290	0.5	270	0.5	290	1	2	190	2	Y	L
23 Oct 03	10:39	HA	01	36 10 2.5 S	150 47 8.0 E	02 212			5	290	0.5	270	0.5	290	1	2	180	2	Y	L
23 Oct 03	11:40	HA	01	36 11 5.5 S	150 47 8.1 E	214			5	290	0.5	270	0.5	290	1	2	180	2	Y	L

Comments

Vessel Activity Codes: DO - dodging, DR - drifting, SE - setting, HA - hauling, ST - steaming, SR - searching, AN - anchoring, GT - cage towing

Offal Discharge Level: OT - other, PR - processing, JF - jigging, TL - trolling, JF - in port, BW - bad weather, BD - broken down

H - high, M - medium, L - low, N - negligible

Attachment 7



OBSERVER PROGRAMME

LONGLINE VESSEL SHOT DETAILS

OBSERVER NAME	ANDY JOESON	OBSERVER TRIP ID	VI 14
VESSEL NAME	VIXEN	OBSERVER PROJECT	TORL LINE 38gram
DATE	230403	SHOT NUMBER	01

SHOT DETAILS

TOTAL # OF HOOKS SET	800
# OF BUOYS SET	100
# OF BEACONS SET	05
# OF HOOKS PER BUOY	8
DIST BETWEEN BRANCHLINES (m)	30
MAX HOOK DEPTH (m)	70
MIN HOOK DEPTH (m)	10
PRIMARY TARGET SPECIES	YFT
SECONDARY TARGET SPECIES	BET
VESSEL SETTING SPEED (kts)	7
LINE SHOOTING SPEED (m/s)	7
TIMER SETTING (seconds)	8
TDR DEPLOYED (circle)	Y <input checked="" type="radio"/> N
BAROMETER (mb)	1000
BAROMETER (circle)	Rise <input type="radio"/> Fall <input type="radio"/> Steady <input checked="" type="radio"/>

BAIT USED

SPECIES	LIFE STATUS	HOOK PSN	HOOK NO.	WEIGHT	THAW STATE
TUZ	S	M	Random	250	NA

LIGHTSTICKS USED

COLOUR 1	Green
COLOUR 2	
HOOK NUMBERS 1	2, 4, 6, 8
HOOK NUMBERS 2	
DISTANCE FROM HOOK (m)	2
No DEPLOYED	395
No RETRIEVED	287

FEATURES OF SHOT

FEATURE	Y	N
ON OR BETWEEN CONTINENTAL SHELF	Y	N
OVER SEAMOUNTS / CANYONS	<input checked="" type="radio"/>	N
ACROSS TEMPERATURE FRONT	Y	N
OBSVIOUS BAITFISH ACTIVITY IN AREA	Y	N
SST IN TARGET SPECIES RANGE	Y	N
ALONG / THROUGH TIDE LINE	<input checked="" type="radio"/>	N
OTHER		

REASONS FOR SHOT

REASON	Y	N
KNOWN AREA		Y
PREVIOUS SHOT		Y
PREVIOUS TRIP		Y
OTHER VESSELS	<input checked="" type="radio"/>	N
NEW GROUND - EXPLORATORY FISHING	Y	N
OTHER		

VALID SHOT

FEATURE	Y	N
NORMAL SHOT	<input checked="" type="radio"/>	N
INTERACTED WITH OTHER VESSEL	Y	N
TIDE AFFECTED	Y	N
UNFAVOURABLE SST	Y	N
BREAKDOWN	Y	N
MAINLINE TANGLE	Y	N
BRANCHLINE BIN TANGLES	Y	N
USED UP ALL BAIT	Y	N
INJURED CREWMAN	Y	N
OTHER		

SHOT CONFIGURATION

CONFIGURATION	Y	N
STRAIGHT LINE	<input checked="" type="radio"/>	N
ZIG ZAG	Y	N
U BEND	Y	N
FOLLOW DEPTH CONTOUR	Y	N
FOLLOW TEMPERATURE GRADIENT	Y	N

DATA SOURCE

SOURCE	Y	N
OBSERVER PERSONALLY COLLECTED DATA	<input checked="" type="radio"/>	N
CAPTAIN ENTERED DATA	Y	N
DATA EXTRACTED FROM LOGBOOK	Y	N

OBSERVER ACTIVITY

# OF HOOKS ACTIVELY OBSERVED	800
% OF OBSERVER COVERAGE	100

COMMENTS

OBSERVER PROGRAMME

OBSERVER NAME: **ANDY JOESON**

VESSEL NAME: **VIKING**

OBSERVER PROJECT: **TORALINE 38**

OBSERVER TRIP ID: **VI 14**

SHOT NO: **01**

SHOT DATE: **23/07/03**

START SHOT TIME: **0 15:30**

BIOLOGICAL DATA

Time (dd/mm)	Species Code	Catch Locn	Tag / Band or Scar	Life Status	Fate	Length (cm)	Length Code	Weight Whole (kgs)	Weight Dressed (kgs)	Process Code	Sex M-F-U	Gonad Stage	Sample (dd:mn)	Code	Comments (Gut contents, tag #)
23045	SEEL														
1045	NO15														
1820	YFET	5			R	103	LCF			GOA	F				Radio Beaman 05
1741	BEIT	5			R	143	LCF			GOA	M				Radio Beaman 05
0151	YFET	1			D										
0800	R1014				S	100	LCF			GOA	F				
0805	ALX				R	100	OFL			GOA	F				
0809	MLC	1			R	110	LCF								
						171	BFL								
1001	SWO	3			R	200	OFC			FL	F		2301	SP	
						220	LCF								
						280	TRFL								
1103	PFC	2			D										

2302 WH retained and placed in a Bag

Life Status: 0 - dead and damaged
 1 - dead, in rigor
 2 - dead and flexible
 3 - alive - just
 4 - alive sluggish
 5 - alive and vigorous

Fate: R - retained, kept for commercial or crew consumption
 D - discarded, landed and not retained
 J - jerked free - crew jerked free, all free without landing
 E - escaped - bitten off
 U - unknown - did not observe
 T - tagged fish and returned to sea

Length Codes LCF - length to caudal fork
 TOT - total length
 STL - standard length
 BFL - bill to caudal fork length (billfish)
 LFL - lower jaw to caudal fork length (billfish)
 ORL - orbit to caudal fork length (billfish)

Tag Band Scar T - Tag Present
 S - Scar from tag evident, no tag present
 N - no tag or scar
 U - unknown

Sex M - Male
 F - Female
 I - indeterminate
 U - unknown



Australian Fisheries Management Authority

OBSERVER PROGRAMME

OBSERVER NAME **ANDY JOESSON**

VESSEL NAME **NIXEN**

OBSERVER PROJECT **TORL LINE 38**

OBSERVER TRIP ID **V114**

YEAR **03**

MONTH **04**

WILDLIFE ABUNDANCE DATA

Start Day & Time dd/mm/yy	End Day & Time dd/mm/yy	Shot Number	Observation Sector	Species	Count	Count Method	Behaviour	Behaviour Percentage	Sex	Age Class	Comments (observed tags, bands or other markings)
23/15/30		01	3/14	SEI1	10	AC	INT	100		ADT	
			1/14	PPEC	5	AC	TOT	100			
			1/14	PDIM							
23/15/32		01	3/14	SEI1							
			1/14								
23/16/50		01	3/14	SEI2	30	EC	INT	20			
			1/14	PPEC			INT	40			
			1/14				TOT	40			
23/16/52		01	3/14	SEI2							
			1/14								
			1/14								
			1/14								
			1/14								
			1/14								
			1/14								
			1/14								
			1/14								
			1/14								
			1/14								
			1/14								

Attachment 7

Observation Sector: 1 - starboard bow, 2 - port bow, 3 - port stern, 4 - starboard stern

Count Methods: AC - Accurate Count, EC - Estimated Count, XC - Extrapolated Count, LN - Extrapolated from logbook observer not present, LP - Extrapolated from logbook observer present, OC - Other Methods

Behaviour Codes: INT - Intensively searching, IRR - Irregularly searching, TOT - totally disinterested, ROM - roosting widely

Sex: M - Male, F - Female, I - indeterminate, U - unknown

Age Class Codes: UNK - unknown, ADT - adult, JUV - juvenile, SUB - subadult

Date: 230403 Vessel: VIXEN Observer Trip ID Number: VI 14 Shot Number: 01

Tori Line

Number of tori lines deployed: 2
 Number of hooks set with tori lines deployed: 850
 Number of hooks set without tori lines deployed: 0
 Average time taken to deploy tori lines (minutes): 10
 Average time taken to retrieve tori lines (minutes): 10

Setting arrangement of tori poles (Tick Box) Permanently fixed in position
 Deployed into position for set

Reason for no tori lines or poles: _____

Deployment & Recovery

What was the method of deploying & recovering the tori lines? (Tick Box)
 By hand
 Manual pulley or winch
 Mechanical pulley or winch

Efficiency: Poor Good Very Good
 Deploying:
 Recovery:

Tangles

How many times did the fishing gear tangle with the tori lines: 1
 Describe reason for tangle & method of remedy: Cast Beacon caught in tori line during set. Remedy vessel stopped + tori line pulled in to free beacon

Incidence of Damage

How many times did the tori lines damage:
 Snoods: Mainline: Buoys: Radio Beacons: Vessel:
 Tori Poles: Other Tori Line:
 Describe reason for damage and method of remedy: _____

Hooks & Line Weighting

Deployment

Number of snood bins used (circle): 1 2
 Position baits deployed (tick box): Port Side Starboard Side Alternate
 Baits enter water forward or aft of stern? AFT Distance from stern where baits enter water (metres): 2
 Method of snood deployment (tick box): (1) Bait deployed first, snood fed from bin
 (2) Snivel and snood deployed first and bait deployed last

Number of hooks deployed with weighted swivels: 950
 Number of hooks deployed without weighted swivels: 0
 Reason for no weighted swivels: _____
 Line shooter used (Y/N) Average mainline tension during shot (tick box) Slack Medium Tight Mixture

Effectiveness

(aim is to place baits under the tori lines for protection)
 What % of hooks were: (1) Deployed under the tori lines - full protection: 100
 (2) Deployed to port or starboard of the tori lines - no protection: _____
 Reason for poor deployment strategy, remedy: _____

Influence of weather

What was the effect of the wind speed and direction (as described in the setting details) on the position of the tori lines in relation to the baits (tick box): Tori lines over baits - full protection Tori lines to port or starboard of baits - no protection
 Did the setting crew change their deployment strategy in order to make the tori lines more effective (Y/N): _____
 Describe: _____

Incidence of line weighting - risk to crew safety

Cause of risk (tick box): Snood tension released by hook being severed or pulled from fish
 Airborne due to snood puller velocity
 Misjudgment by crew of snood recovery
 Other: Describe: _____
 Crew: Vessel Water Other
 No. of times weight collide with: _____
 Describe outcome: Bruised left hand
 Injury Sustained (Y/N) Describe: _____
 How did vessel address the crew safety issue (tick box): Helmets with visors Slow hauling awareness Other
 Describe: No mitigation action taken

Observer Name: ANDY JESON
 Observer Signature: ANDY JESON



Tori Line Instructions

This tori line has been provided to you unassembled. The following instructions detail the construction of the line so that it conforms to the conditions detailed in the fishing permit for this vessel. This set of instructions gives a tori line height of 8 metres.

It is compulsory to use the tori line when fishing during day light hours in the area of water south of 25° South.

Your Kit Contains:

- 100m roll of 4.5mm Kuralon for tori line backbone
- 130m roll of 9.8mm Kraton streamer material (orange)
- 120m roll of 4.2mm Kraton streamer material (yellow)
- 1x 6mm snap clip
- 10x "A" 5.2mm lock crimps
- 1x packet of cable ties
- 1x 4 inch polystyrene float
- 1x 6 inch polystyrene float
- 1x 10 inch hard plastic float
- 1x 900mm cone

Tori Line Construction

1. The tori line is to be attached at a height of 8m from the surface of the water.
2. Unroll Kuralon and, using a crimp, attach the snap clip to one end. This end will be attached to the tori pole. The Kuralon is the backbone of the tori line and has already been cut to length.
3. The tori line consists of two types of streamers – a longer, paired streamer (9.8mm orange Kraton) and a shorter, double-paired streamer (4.2mm yellow Kraton) which alternate along the tori line backbone.
4. The length and positioning of the streamers is detailed in Table 1 over the page.
5. Cut a 15.4m length of orange Kraton. Using a cable tie, attach the middle of the length of Kraton to the tori line backbone making two streamers of equal length.
6. Cut two lengths of 7.4m yellow Kraton. Using a cable tie, attach the middle of both to the backbone at 3.5m from the first streamer.
7. Continue alternating the streamers at 3.5m intervals according to the streamer lengths detailed in Table 1.

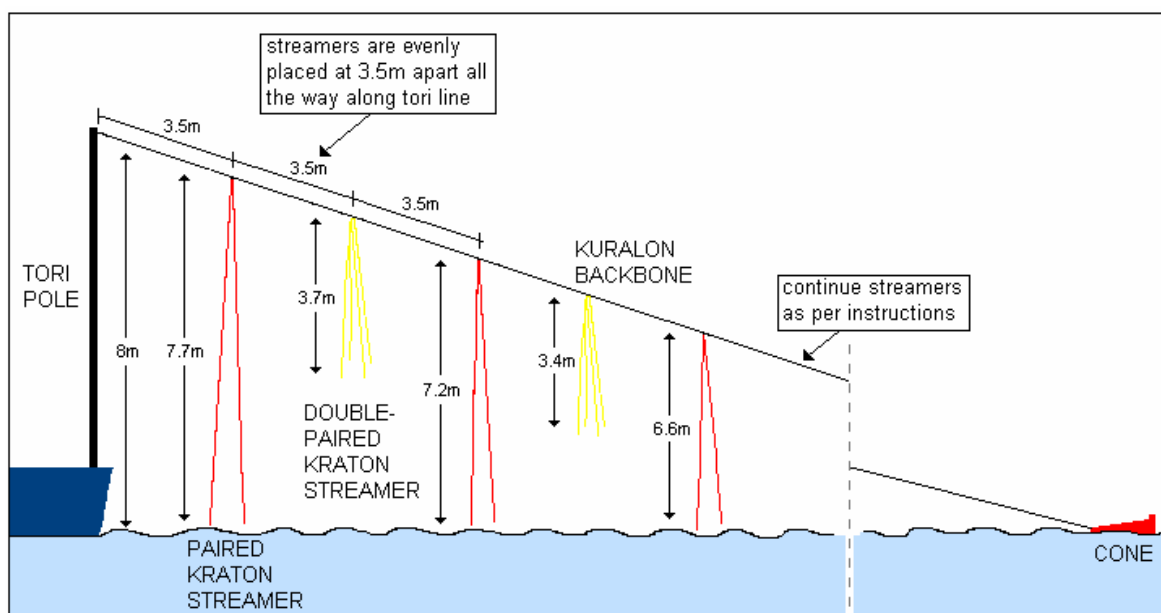

Table 1. Streamer Lengths

KRATON STREAMER COLOUR	LENGTH OF STREAMER (m)	CUT LENGTH (m)	PLACEMENT OF STREAMER FROM BOAT END(m)
Orange	7.7	15.4	3.5
Yellow	3.7	7.4 (x2)	7.0
Orange	7.2	14.3	10.5
Yellow	3.4	6.9 (x2)	14.0
Orange	6.6	13.2	17.5
Yellow	3.2	6.3 (x2)	21.0
Orange	6.0	12.1	24.5
Yellow	2.9	5.8 (x2)	28.0
Orange	5.5	11.0	31.5
Yellow	2.6	5.2 (x2)	35.0
Orange	4.9	9.8	38.5
Yellow	2.3	4.6 (x2)	42.0
Orange	4.4	8.7	45.5
Yellow	2.0	4.1 (x2)	49.0
Orange	3.8	7.6	52.5
Yellow	1.8	3.5 (x2)	56.0
Orange	3.2	6.5	59.5
Yellow	1.5	3.0 (x2)	63.0
Orange	2.7	5.4	66.5
Yellow	1.2	2.4 (x2)	70.0
Orange	2.1	4.2	73.5
Yellow	0.9	1.8 (x2)	77.0
Orange	1.6	3.1	80.5
Yellow	0.6	1.3 (x2)	84.0
Orange	1.0	2.0	87.5

CONE/FLOAT CONSTRUCTION

1. Drill a hole (longways) through opposite feet on base of cone.
2. Insert small (4") then medium (6") float into the cone making sure that the holes align with the hole in the top of the cone.
3. Thread Kuralon backbone through the top of the cone and through the floats. Top of cone should point towards the boat end.
4. Tie off the end of the Kuralon to the eye of the large float and insert the float into the base of the cone.
5. Pull on the Kuralon to pull floats tight in the cone.
6. Pass a length of rope through the eye of the float and the drilled holes in the feet of the cone.
7. Tie off the rope (tightly) at both feet so that the rope holds the float firmly in place.

**For more information
Contact AFMA Direct on
1300 723 621**

